



Softopper Installation Instructions

Jeep Gladiator

Please read instructions thoroughly before starting installation, or find our new installation video on YouTube under “Softopper Official Installation Video for Trucks”!

****Remove all contents of the Softopper carefully to protect from scratches.**
Windows scratch easily! Keep protective layer placed between them when they are stacked.**



Estimated Installation Time: 1 hour

Beginning Note: It is easiest to do the initial installation in warmer temperatures. The fabric of the top is at its tightest when it is new. Installing it in warmer temperatures initially will ensure that the fabric is easier to work with. The fabric of the top will relax slightly with time and become easier to put on.

****Safety Notes****

Please read the following before driving with the Softopper installed:

1. It is highly recommended that a boot cover/storage bag (sold separately) is used when the topper is in its retracted position. This will prevent the top from catching in the wind and extend the longevity of the soft top.
2. DO NOT rely in any way on the soft top to contain occupants or objects within the vehicle bed, or to protect against injury or death in the event of an accident or a roll-over.
3. This top will not protect the occupants or objects from falling or flying objects. Never operate vehicle in excess of manufacturer's recommendations or specifications.

Tools needed for installation:

- #2 Phillips Screwdriver
- #3 Phillips Screwdriver
- 9/16" Wrench or Socket
- Drill
- #2 Phillips Drill Bit
- Pencil or Marker
- 1/8" Drill Bit (optional; see page 14, "Installing Snap Screws", for more details)

Table of Contents

1. Inventory.....	3
2. Hardware Installation	
1. Bedrails.....	4
1. Clamps.....	7
2. Folding Frame.....	9
3. Soft Top Canopy Installation.....	12
1. Snap Screws & Velcro.....	1
4. Rear Bar Installation.....	17
5. Retracting the Soft Top.....	18
6. Optional Driving Configurations.....	20
7. Rear Screen Installation (*Purchased Separately)....	22
8. Softopper Care and Maintenance.....	23
9. Warranty Information.....	24

Your Softopper Kit Includes the Following Pieces

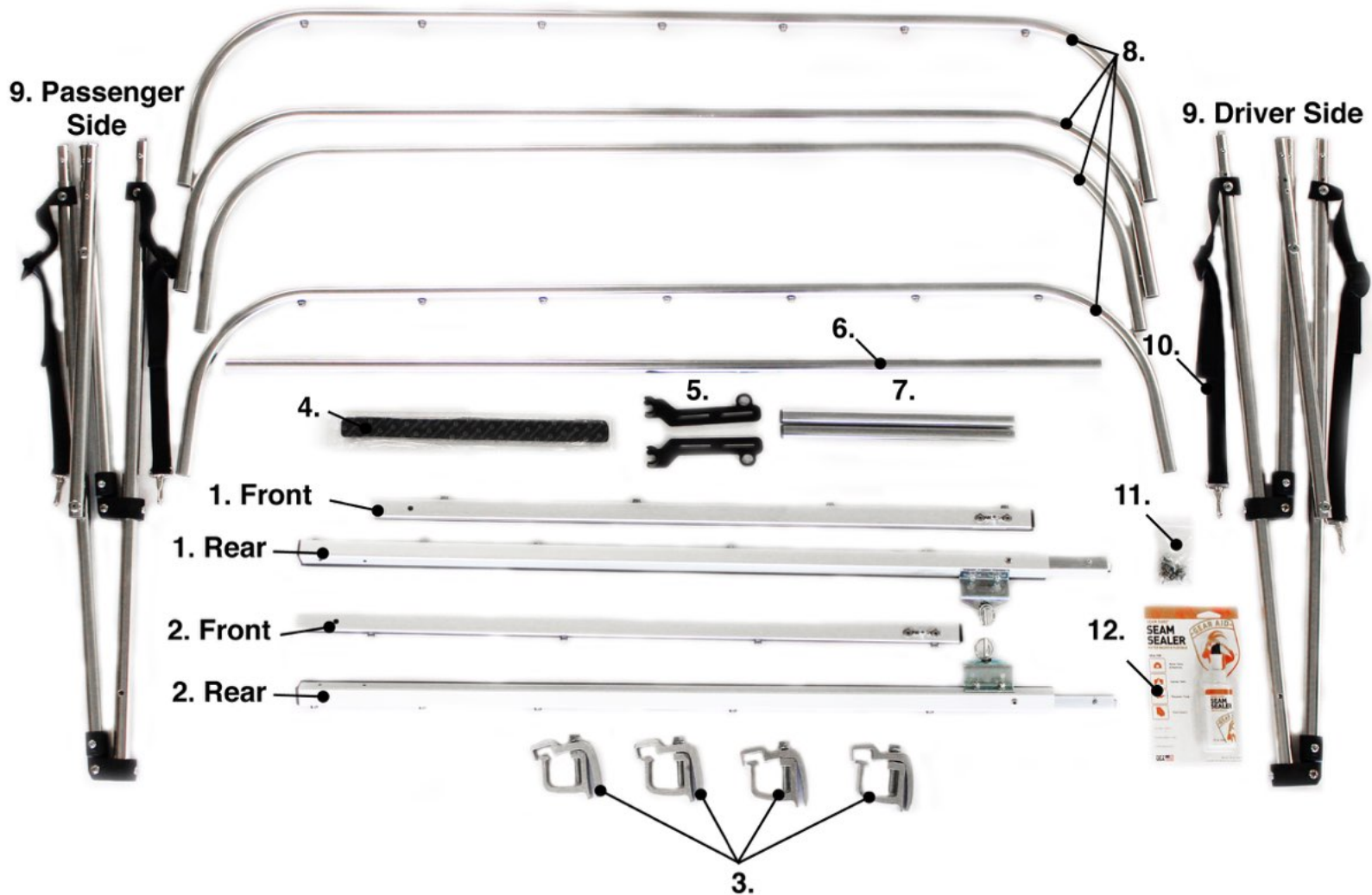

1. Front and Rear Driver Side Bedrails
2. Front and Rear Passenger Side Bedrails
3. 4 Clamps (6 for Long Beds) (Clamp Styles May Vary)
4. Velcro
5. 2 Black Plastic Rear Bar Retainers
6. Rear Window Bar
7. (2) 12" Rear Window Bars
8. 4 Cross Bars
9. Diver and Passenger Side Folding Frames
10. Safety Straps
11. Small Bag Containing Hardware
12. 1 Bottle of Seam Sealer
13. 1 Softopper Canopy (not depicted above)

Bedrail Installation

****Note**** Driver side depicted in all photos and illustrations throughout instructions. Also, colored instructions are available on our website, softopper.com, under “Installation Instructions”.

1. Locate the 2 driver side bedrails. There is a sticker which designates the driver side front bedrail.



2. Remove the white protective paper from the bottom of the bedrails that is covering the weather stripping. The weather stripping is NOT ADHESIVE, and will not stick to your truck.



3. Join the driver side front bedrail piece and the driver side rear bedrail piece by pressing down on the push pin, as shown, and sliding the rear bedrail into the front bedrail until the push pin finds the hole and pops through. Make sure that you have the driver side rear bedrail piece by ensuring that the snaps on the front and rear bedrails are facing the same direction.

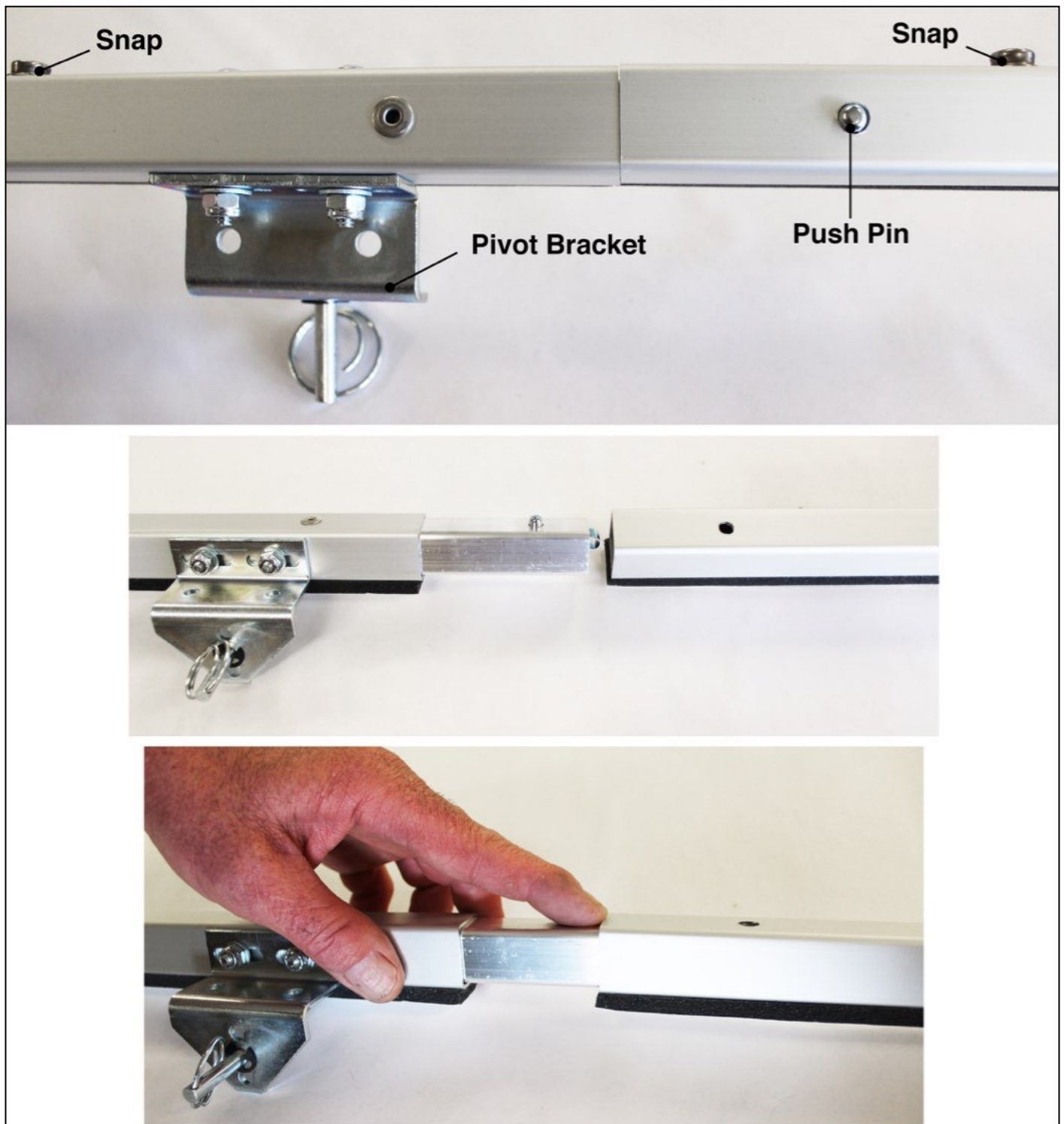

4. Repeat for passenger side bedrails.

5. Locate the 2 black, plastic rear bar retainers and the small bag containing hardware.
6. The plastic retainers are marked “A” and “B”. “A” is the driver side piece, and “B” is passenger side piece. The retainer slot should face inward and the ring should be up as shown.



7. Using the (4) #12 x 3/4” panhead screws and a #3 Phillips screwdriver, mount the rear bar retainers to the pre-drilled holes on the back end of the rear bedrail as shown. Center the



screws in the slots.

8. Repeat on passenger side bedrail with the plastic retainer marked “B”.

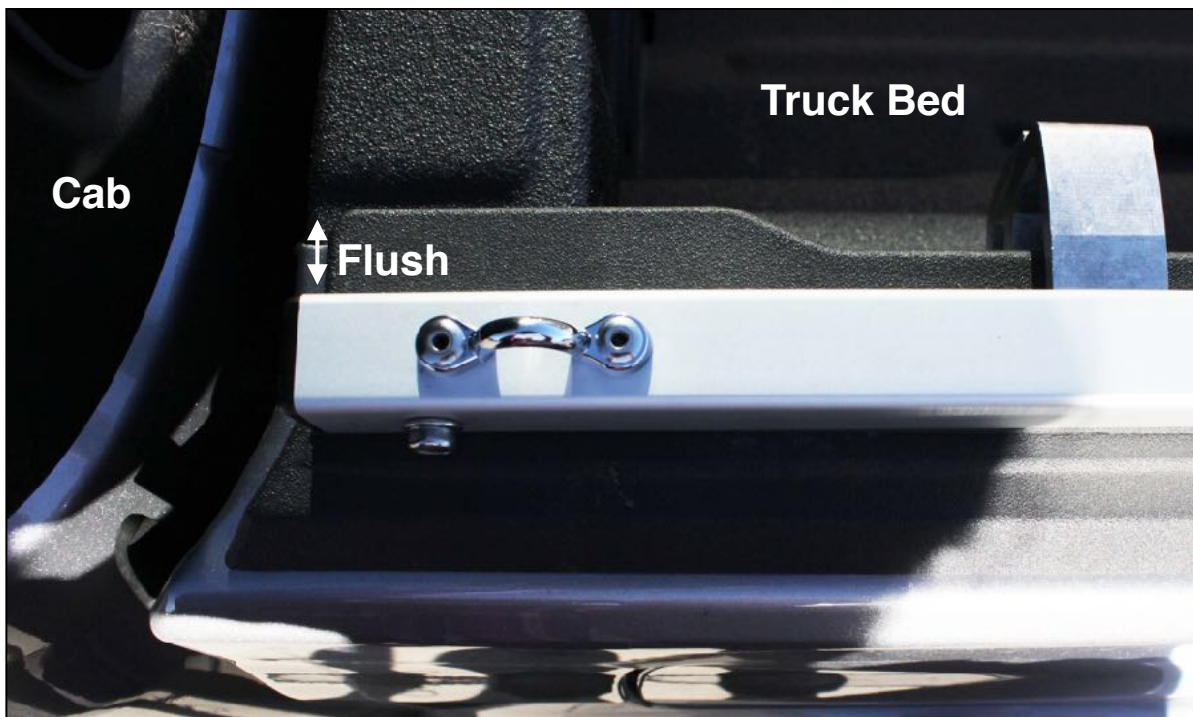

9. Place the driver side bedrail atop the side of the truck's bed side rail with the snaps facing out, the rear bar retainer facing in, and the weather stripping down. The metal pivot bracket will hang over and down the truck's side rail towards the truck bed.
10. Align the front edge of the bedrail with the front edge of the truck side rail black plastic. The bedrails may need to be moved slightly later.
11. Align the inside edge of the bedrail about 1/2" - 3/4" out from the inside edge of the truck side rail.
12. Repeat on passenger side with passenger side bedrail.

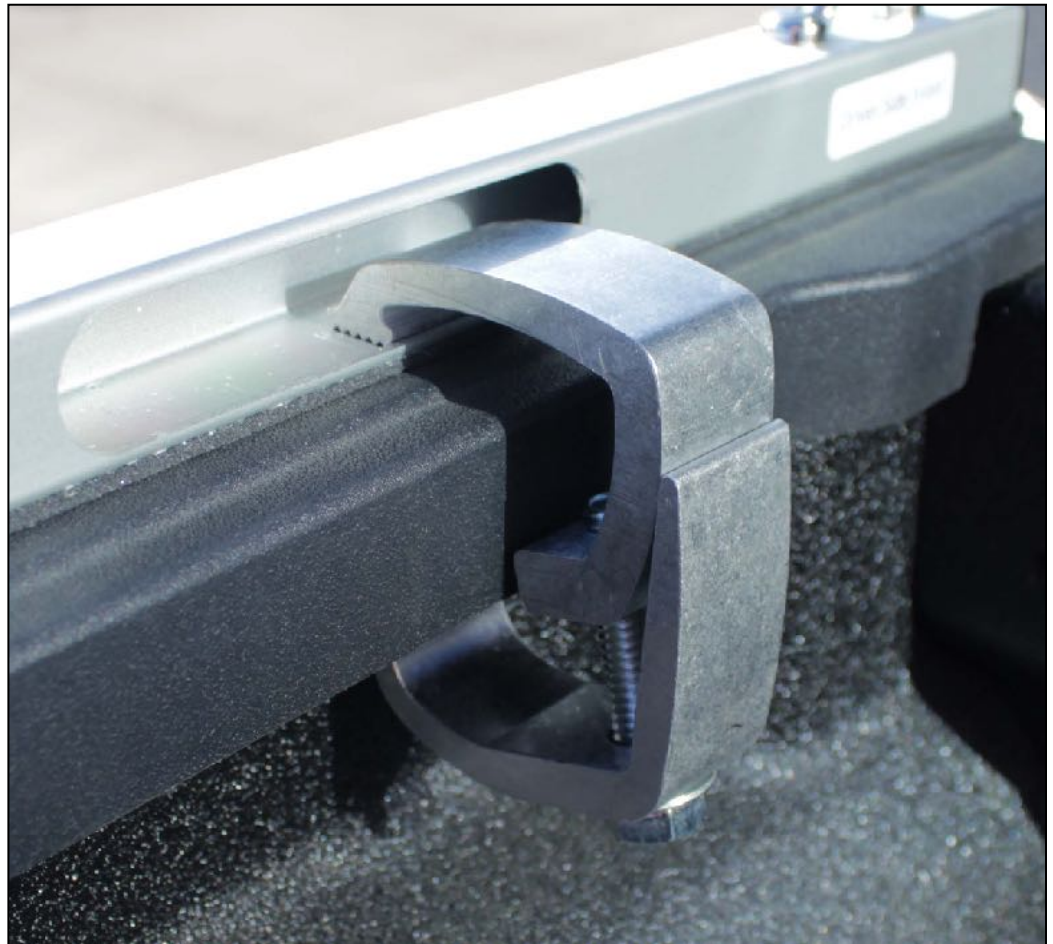

13. Locate the 4 clamps in your kit. Follow the instructions below that correspond to your clamp style.

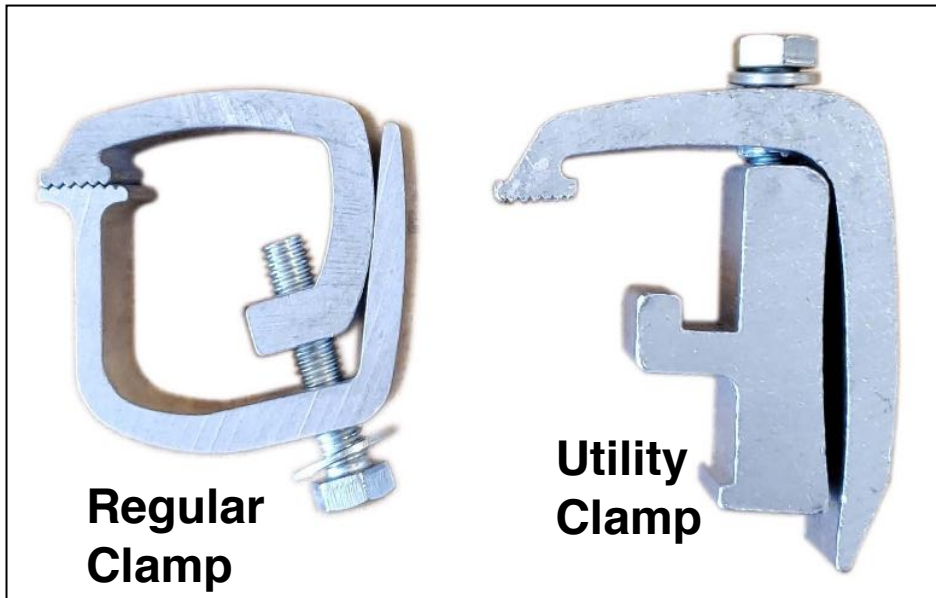

14. Regular Clamps:

1. Placement of the clamps should be approximately within the slots in the side of the bedrails.
2. Install the clamps by carefully placing them, BOLT SIDE DOWN, under the truck's side rail and into the slots of the Softopper bedrail. Some vehicles have ridges under the side rail. In order to ensure a secure fit, avoid clamping onto such ridges.
3. Using a 9/16" wrench or socket, snugly fasten the clamp bolts until the bedrail is not able to shift. Do not over tighten. The bedrail location may need to be adjusted later in the installation process.

2. Utility Clamps:

1. Locate the utility track, which is just under the truck bed side rails.
2. Install the clamps by carefully placing them, bolt side up, under the truck's side rail, into the utility track, and over the top of the Softopper bedrail as shown. Ensure that the flange on the clamp is securely latching all the way into the utility track.
3. Using a 9/16" wrench or socket, snugly fasten the clamp bolts until the bedrail is not able to shift. Do not over tighten. The bedrail location may need to be adjusted later in the installation process.
4. Place the 4 black plastic caps over the clamp bolts.



Folding Frame Assembly and Installation

1. Locate the 4 Cross Bars and the 2 Folding Frames.

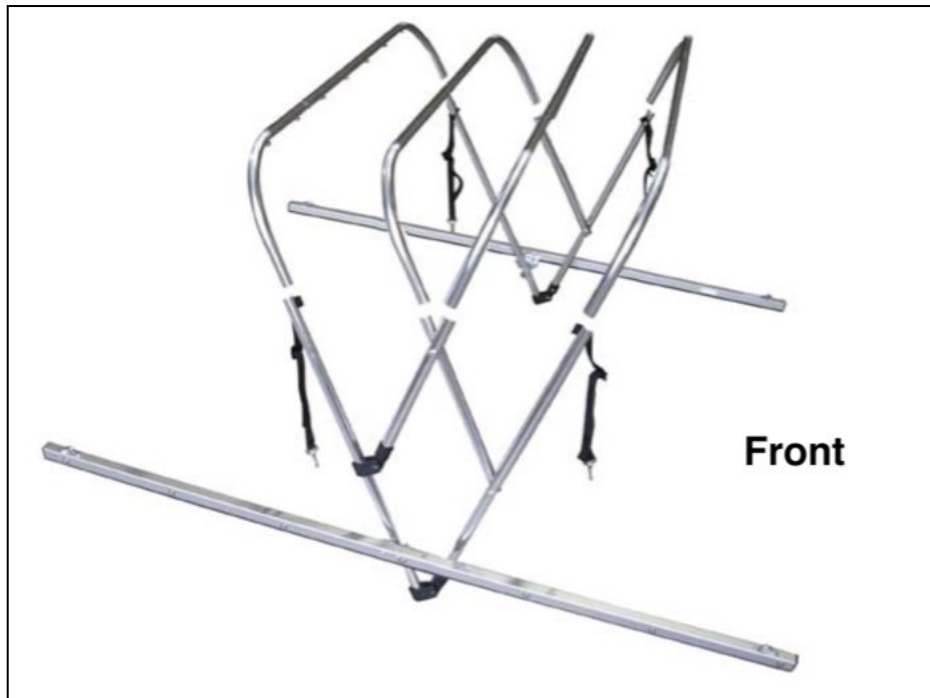

2. Join the 4 cross bars to the 2 folding frames by coordinating the **COLORED DOTS** provided on the pieces and ensuring the push pins are locked into their holes.
****Important: Keep fingers clear of the sharp, metal junction where the cross bars will meet the folding frame when clipping them together. Injury is likely if fingers get pinched.**



3. ****Tip: It helps to stand the folding frame uprights up, and with another person, or a table to rest one end of the cross bars on, jiggle the cross bars down to join them to the uprights.**

4. Remove the safety rings from the pivot pins in the pivot brackets by turning the ring.

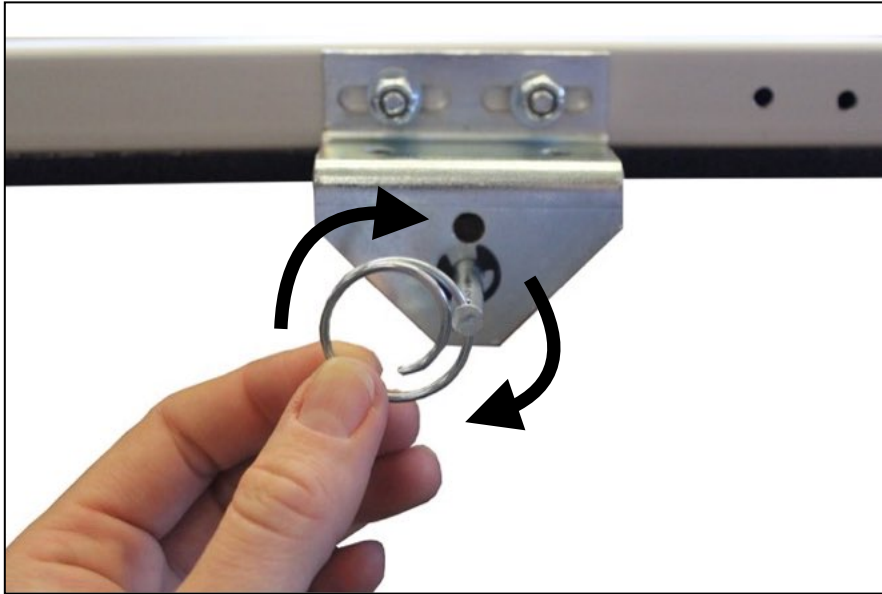

5. Using the pre-drilled holes near the bottom of the folding frame, slide the frame onto the pivot pins on each bedrail ensuring the **forward cross bar is forward**. The forward crossbar is the one with the **RED DOT**. Secure the safety rings back on. [The most common installation error is installing the frame on backwards. View photo to ensure correct orientation of the folding frame.]

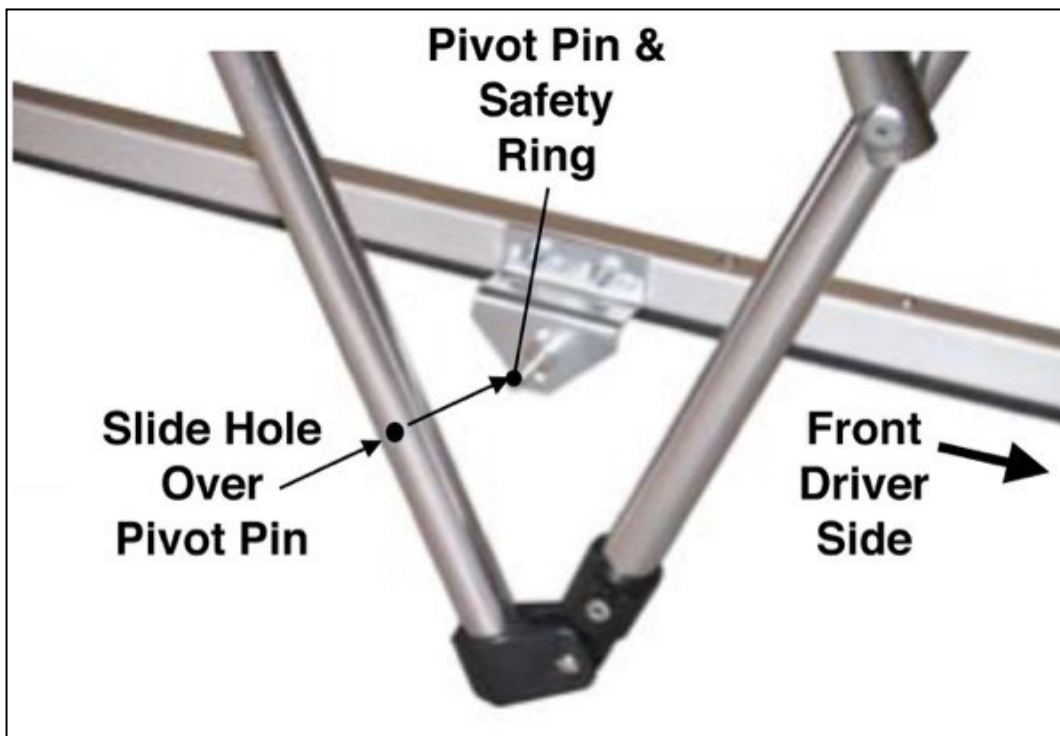

6. **Note:** when reopening the frame from its front position, you must raise all of the cross bars to approximately cab-height before opening the folding frame completely. If the rear cross bar is raised on its own, it will force the forward most cross bar into the cab window.



7. Leave the 4 safety straps that are hanging on the folding frame unclipped for now.
8. If needed, realign the bedrails so that the crossbars rest on top of the 2 clamps at the front of the bedrails, and don't impact the cab window. Tighten clamps after finalizing the bedrail placement.



Soft Top Canopy Installation

1. With the tailgate open, lower the folding frame to the rear of the vehicle.
2. Carefully place the canopy on the tailgate, as shown.



3. Locate the rear window panel snap flap and place it facing up and forward. The rear window has zippers, but the front one does not.
4. Snap the canopy to the snaps on the bottom/rear most cross bar by slipping the fabric **UNDER** the bar and around as shown. Snap the 2 outward most snaps first, then the remaining snaps.

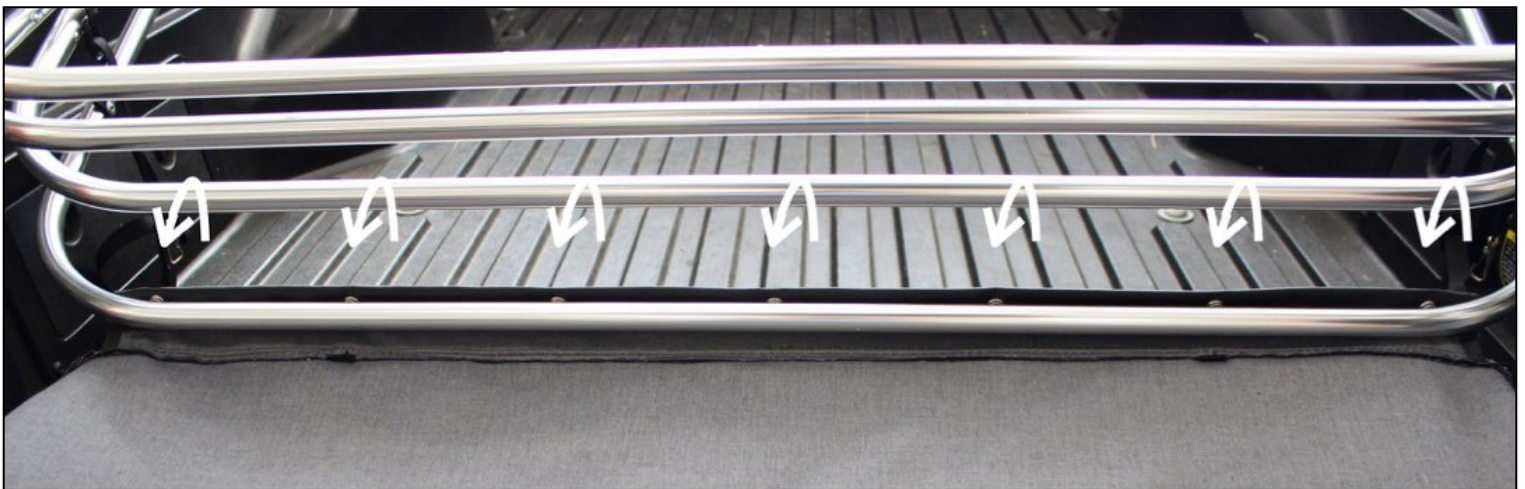

5. Locate the front snap flap.

6. With the snaps facing down, wrap it **OVER** the upper/forward most cross bar (the other one with snaps), and snap all the snaps in the same manner as the rear.

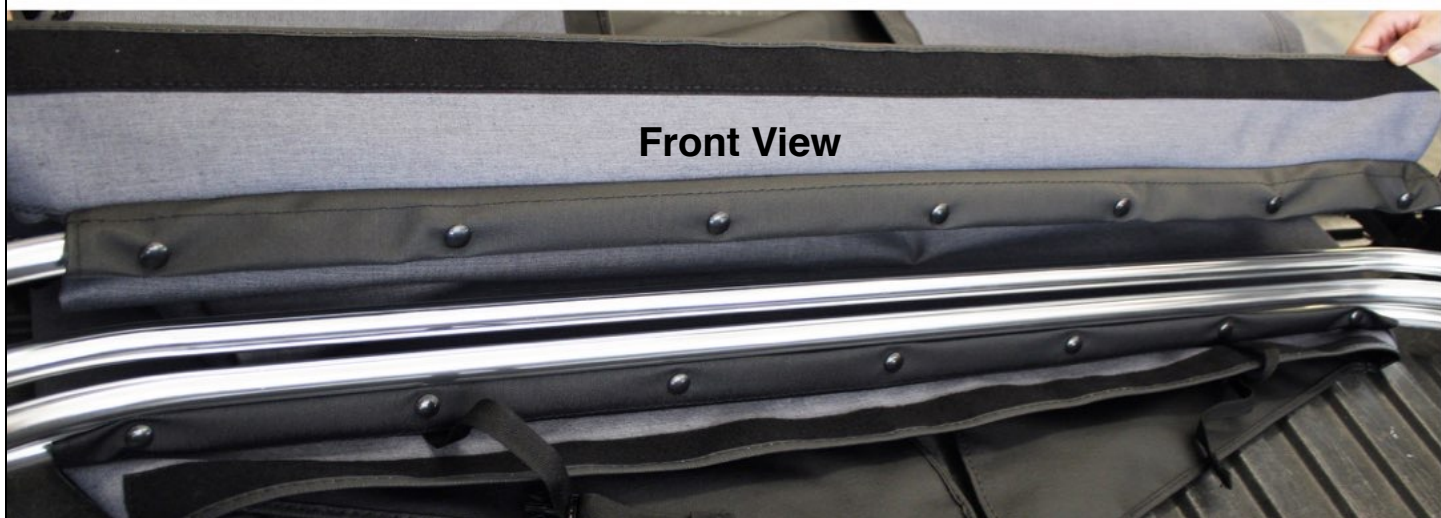

7. From the side of the vehicle, raise the folding frame up into its upward position.

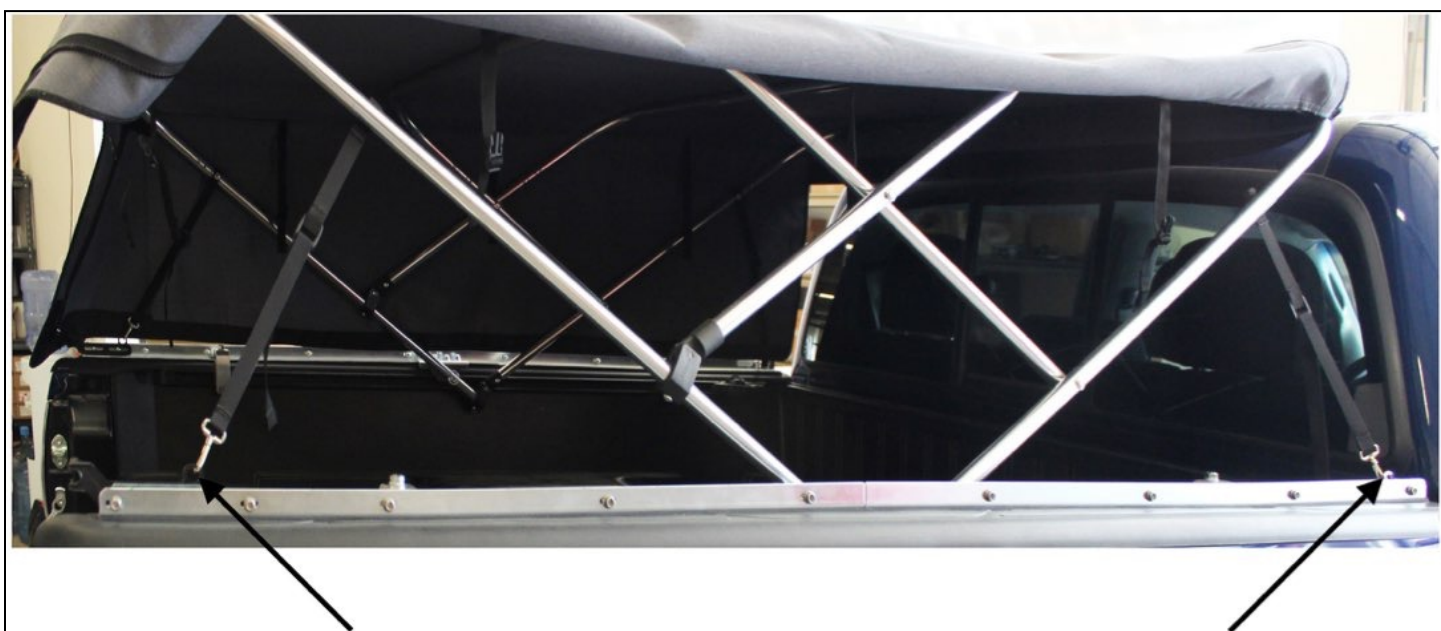

- Loosely latch the 2 rear safety straps to the rings on the plastic rear bar retainers and the 2 front safety straps to the bedrail loops as shown above. The straps are already riveted to the folding frame.
- Undrape the side panels and rear window panel, and let them hang loosely.

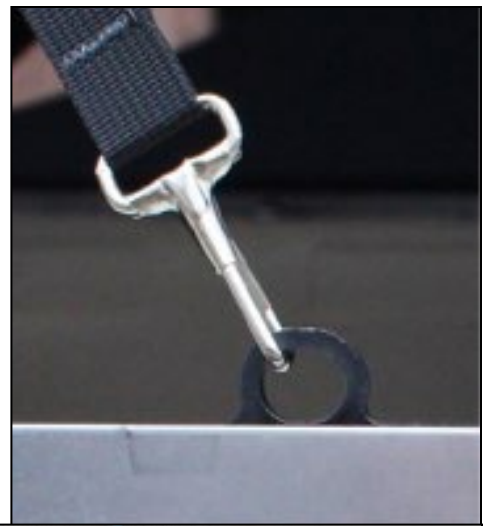

- On the driver side, snap the 2 forward most snaps to the bedrail.
- On the same side, while pulling down on the rear cross bar, tighten the rear safety strap. The safety straps should be snug, not loose nor overtightened.
- Connect the rear most snap on the side panel to the rear most snap on the bedrail.
- Tighten the safety straps further to relieve excess tension on the snaps. ****Note that it is a good idea to share tension between the safety straps and the snaps instead of having all the tension only on the snaps.** This will also help with any wrinkles in the corners.
- Now snap the rest of the snaps on the driver side.
- Repeat the above on passenger side. Note that we recommend snapping the front most and rear most snaps first each time you close the top. This makes it easier to snap the remaining snaps and align the canopy properly.



- Place the front window down between the cab and the bed with the lower snap flap inside the truck bed and the outer flap between the bed and the cab.
- Center the front window.



18. **Pivot Bracket:** *Note that this is already installed on the bedrails.* However, at this point or at any other point during the life of your Softopper, if the canopy is too loose or too tight, you can move the pivot pin to a higher or lower hole in the pivot bracket. Be sure to reinstall the black, plastic E-Clips onto the pivot pins. Also, ensure with any new adjustments that the folding frame does not impact the cab window. Make sure the E-Clip is in the small indent in the pivot pin. It helps to use the flat edge of something metal to push the E-Clip on. ****Again, this is already installed for you.**

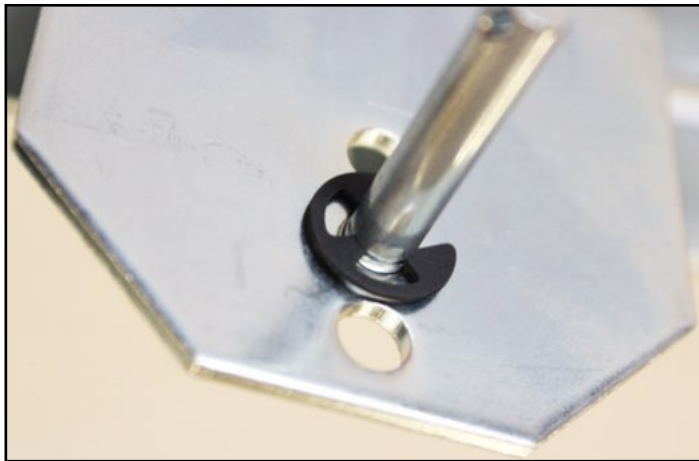

19. **Front Window:** There are 2 ways to secure the front window panel so that it doesn't flap while driving. Use the provided snap screws to snap the window panel to the inside of the truck bed, or use the provided velcro to velcro it. If you don't want to drill into the bed of the vehicle, we recommend using the velcro. However, the velcro will not adhere to some bed liners. In this case, the snap screws must be installed. See the next page for both instructions.

20. Installing Snap Screws (Optional):

1. Center the front window from inside the truck bed by lining up the small hole at the top of the window with the center snap on the forward crossbar.
2. Using a pencil or marker, mark the placement for the 3 snap screws on the front of the truck bed while holding the front window snap flap in its correct location.
3. Using a 1/8" drill bit and a drill, drill the three holes for the snap screws. Apply caution. Drill bits are easily broken in this process.

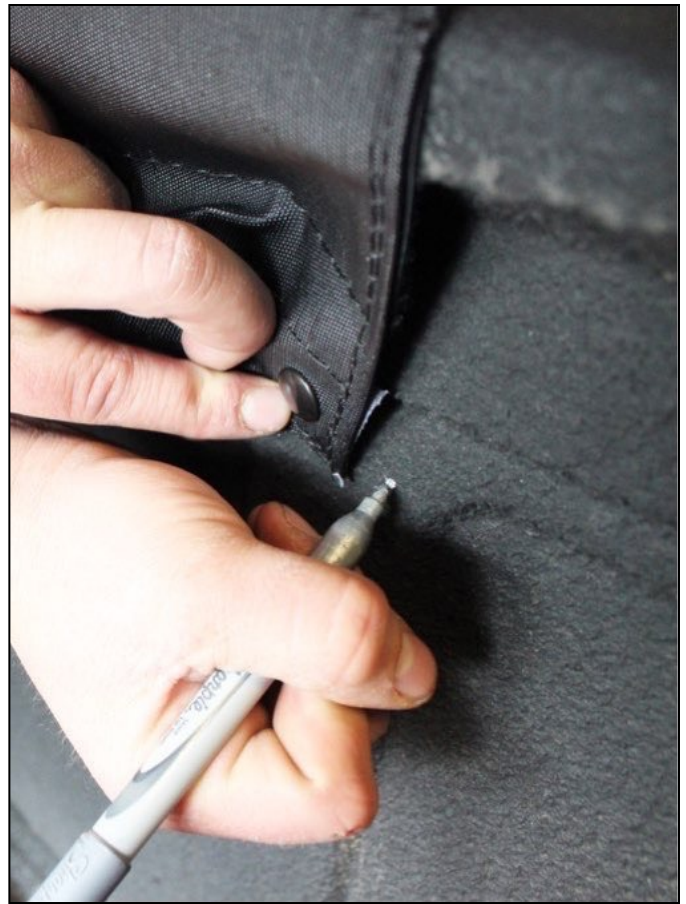

4. Locate the 4 snap screws that are in the small hardware bag. We've provided an extra just in case.
5. Using a #2 Phillips screwdriver, gently screw the snap screws into the drilled holes.
6. Snap the front window snaps to the snaps on the vehicle.

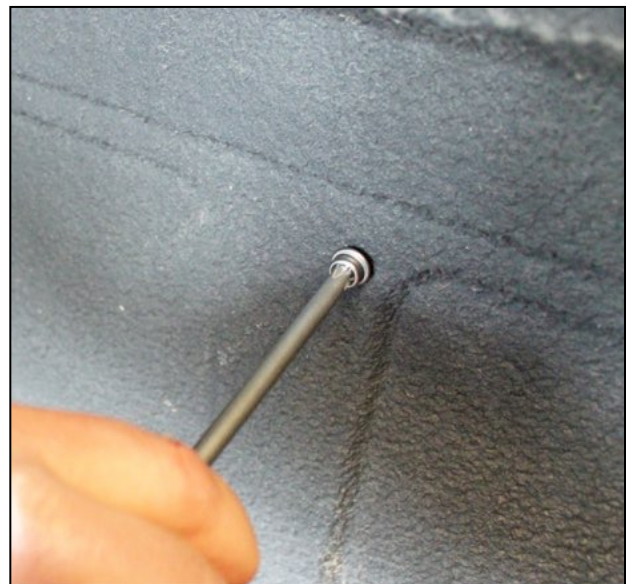

21. OR: Velcro

1. Locate the bag of 14" velcro strips.
2. Place 2 strips of velcro onto the front of the truck bed, near the edges of the window panel, while lining them up with the velcro on the flap of the front window panel.
3. Wipe clean the selected surface of the front truck bed, remove the protective film from the sticky side and firmly press the velcro onto the vehicle.
4. Line up the front window panel velcro and press it securely onto the installed velcro.

22. Locate the straight Rear Window bar, the (2) 12" bars, and the two remaining self drilling screws that were in the bag.



23. Insert the 2 shorter bars into the ends of the longer bar with the plastic end caps facing out.
24. Standing at the rear of the vehicle, push the two ends of the bar assembly into the rear plastic bar retainers while adjusting the length of the bar assembly as necessary. It should fit securely end to end into the given space within the plastic bar retainers as shown.
25. Center the long bar over the other two 12" bars.
26. Using a drill and a #2 Phillips bit, screw the 2 small self drilling screws into the pre-drilled holes to join the 3-bar assembly.
27. Now remove the bar and slide it into the sewn-in sleeve at the lower part of the rear window panel. Center the bar and snap it into the bar retainers.
28. Zip closed the rear window panel.
29. Close the tailgate while lifting up slightly on the fabric hanging at the bottom of the window panel.
30. Secure velcro around the front and rear window panels.
31. ****Optional:** Use the provided extra strips of velcro to hold the bottom of the rear window flap to the tailgate. Wipe clean and dry the tailgate surface before placing the sticky side of the velcro onto the vehicle. Before putting excessive tension on the velcro, we recommend letting it adhere for **24 hours**.



Installation Complete

Retracting the Soft Top

1. Undo all side snaps.
2. Raise the rear window panel zippers all the way to the top without disconnecting them.
3. Release the rear window retainer bar.
4. Optional: Undo velcro or snaps on front window.
5. Optional: Carefully and neatly place front window on top of the canopy without creasing the window. You can leave the front window secured while retracting the canopy. However, we



6. Fold the side panels up onto the roof canopy neatly.
7. Fold the rear window panel up onto the roof as well with the upper zippers still connected.



8. Release the 2 rear safety straps.
9. Standing on the tailgate, or from the side of the vehicle, fold the folding frame forward with the entire canopy on top of the cross bars. The top should fold itself nicely into sections without damaging the windows. Ensure the correct folds are made the first few times.

10. ****Clip the 2 rear safety straps onto the bedrail loops and tighten them for safety while driving.**

11. Optional: Place your Softopper boot cover (purchased separately) around the Softopper to make for clean, easy storage on or off the vehicle.

12. To fully remove the Softopper, release all 4 safety straps, remove the 2 safety rings from the pivot pins, and completely remove the folding frame. Reinstall the safety rings. Optional boot cover can be placed around the Softopper to make for clean, easy storage on or off the vehicle.

13. ****Optional: Roll the side panels and the rear window up to create an open air truck bed without removing the upper canopy as shown. Carefully and neatly roll up the panels and secure them by buckling the straps on the canopy. The truck can be driven with the rear window rolled up, and the sides rolled up. However **DO NOT** drive the vehicle with the side panels rolled up and the rear window down due to wind resistance potentially causing damage to the rear window or release of the rear bar from the bar retainers.**



14. ****Optional: Roll the side panels and the rear window up to create an open air truck bed without removing the upper canopy as shown. Carefully and neatly roll up the panels and secure them by buckling the straps on the canopy.**

Optional Driving Configurations

1. Retracted without boot cover.
**Secure both Safety Straps to bedrail loops!



2. Retracted with boot cover (purchased separately; makes for clean, easy storage on or off the vehicle). **Leave one safety strap on each side out of the boot cover and secure them to bedrail loops!



3. Rear window rolled up and buckled.
4. Rear window removed.
5. Front panel removed.



6. Side panels and rear window rolled up and buckled. **Rear window MUST be rolled up if side panels are rolled up.



7. Side panels partially rolled up.



8. Softopper canopy and folding frame removed from vehicle. Leave bedrails installed. To fully remove the Softopper, release all 4 safety straps, remove the 2 safety rings from the pivot pins, and completely remove the folding frame. **Reinstall the safety rings.** Optional boot cover can be placed around the Softopper to make for clean, easy storage on or off the vehicle.



Rear Screen Installation *Purchased Separately

1. Open the tailgate. Unzip the rear window.
2. Completely remove the rear bar from the rear window.
3. Sit inside the Softopener on the tailgate, facing the rear window.
4. Undo the small, velcro flap covering the top of the zippers on each side of the rear window, and unfasten the zippers from the other half on the Softopener roof.
5. Pull the window to completely detach it from all of the velcro holding it on at the top. Gently place the window in a storage location where it will not get scratched.
6. While still sitting in the truck bed, place the screen panel right side out.
7. Attach the zippers first, and only pull them down a little bit. Secure the small velcro flap over the top of the zipper.
8. Make sure the roll-up straps are on the inside of the screen panel.
9. Find the small hole in the screen panel that is at the top, in the center. Line the hole up with the center snap on the cross bar above the velcro.
10. Secure the velcro all the way across the top of the screen panel evenly. No velcro should be showing on the outside of the window panel.
11. Slide the rear bar into the pocket at the bottom of the screen panel.

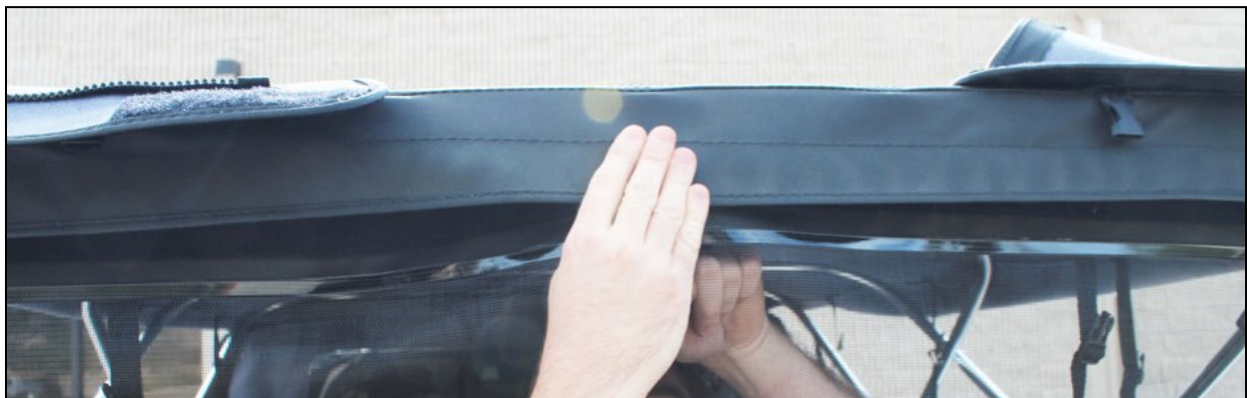

Softopper Care and Maintenance

Your top is made of the finest materials available. To keep it looking new and for product longevity and durability, it will need periodic cleaning and maintenance. All pieces are individually replaceable; call 1-800-810-7227, or order your parts online at Softopper.com.

Washing: The fabric should be washed from time to time using a mild soap and warm water. Be sure to rinse all soap off the top when washing is complete.

Vinyl Windows: Windows should be kept clean to avoid scratching. Wash with a water-soaked sponge or cloth and a mild dishwashing detergent. **Do not use a coarse brush on the windows and never wipe the windows when they are dry.**

COLD WEATHER: As with all automotive and marine vinyls, extreme care must be taken when rolling up or folding the windows in cold temperatures. **Vinyl becomes stiff in cold temperatures and may crack. Retracting the Softopper in cold temperatures is not recommended and will void the warranty for the windows (see Warranty information for more detail on length of window warranties).** When opening the rear of the Softopper in cold weather, be sure to raise the zippers as high as possible so that any folding will occur to the topper fabric and not to the vinyl window.

Zippers: Keeping the zippers clean and lubricated with a silicone lubricant will help prevent damage and keep the zippers in smooth working condition.

Leakage: As with any sewn automotive top there is always a slight risk of leakage. **Right out of the box the Softopper may not be 100% waterproof.** If you experience any water seeping through at the seams, apply **Seam Sure** (supplied), on the inside of the affected seams. **Shake** Seam Sure well and apply liberally to the inside seams concentrating on areas where needle and thread penetrated the fabric.

Snaps: Keep snaps clean and lubricated with a silicone lubricant to help prevent snaps from sticking to the studs. If a snap does become stuck to a stud, use a screwdriver and gently pry apart to prevent damage to the snap or top fabric. If any snaps need to be replaced due to sticking or damage please call Softopper and we can send out a small do-it-yourself repair kit.

For further information please contact:
Softopper LLC, customer service
(800) 810-7227 or (303) 304-0533

Warranty

We warrant all of our Softoppers to be free from defects in material and workmanship for a period of one year, with the exception of vinyl windows and zippers, provided there has been normal use and proper maintenance.

Vinyl Windows are warranted for a period of 3 months from the date of purchase.

Zippers are guaranteed to be in perfect working condition when leaving the factory. Due to atmospheric conditions, dirt, sand, road grime, dust, and abrasive cleaners, etc., zippers are warranted for a period of 6 months from the date of purchase.

Toyota 4 Runner, Jeep Wrangler, Blazer, Jimmy, Scout, Bronco, and RamCharger side curtain windows are warranted for 45 days from the date of purchase. Retracting or closing the top when the temperature is below 40 degrees may void the warranty on the side windows, as clear vinyl plastic can crack very easily at these temperatures. Use caution when retracting the top or cleaning off the windows in freezing temperatures.

Returns must be made within 30 days of purchase, and must be pre-approved and have Softopper's issued RGA number attached. Any defective items must be returned with proof of purchase to Softopper 4750 Nautilus Court South, Unit B Boulder CO 80301, **freight pre-paid**. Items returned must be carefully packed, in clean condition, with plastic windows protected from scratching and creasing. This warranty does not cover damage resulting from abuse, misuse, alteration, accident or damage in transit. Softopper's obligations under this warranty are limited to the aforementioned **repair** or **replacement** of warranty defects for which return authorization has been received during the warranty period, and Softopper SHALL NOT BE LIABLE FOR ANY INCIDENTAL OR CONSEQUENTIAL DAMAGES ARISING FROM BREACH OF THIS OR ANY IMPLIED WARRANTY. This warranty applies to the original purchaser only. All remedies under this warranty are limited to repair or replacement of any item or items found to be defective by the factory within the time period specified.

For further information or request for repair work, please contact:

Softopper LLC, customer service
(800) 810-7227 or (303) 304-0533