



Ridgeline (A) Installation Instructions

Please read instructions thoroughly before starting installation

****Remove all contents of the Softopper carefully to protect from scratches.**
Windows scratch easily! Keep protective layer placed between them when they are stacked.**



Estimated Installation Time: 1 hour

Beginning Note: It is easiest to do the initial installation in warmer temperatures. The fabric of the top is at its tightest when it is new. Installing it in warmer temperatures initially will ensure that the fabric is easier to work with. The fabric of the top will relax slightly with time and become easier to put on.

****Safety Notes****

Please read the following before driving with the Softopper installed:

1. It is highly recommended that a boot cover/storage bag (sold separately) is used when the topper is in its retracted position. This will prevent the top from catching in the wind and extend the longevity of the soft top.
2. DO NOT rely in any way on the soft top to contain occupants or objects within the vehicle bed, or to protect against injury or death in the event of an accident or a roll-over.
3. This top will not protect the occupants or objects from falling or flying objects. Never operate vehicle in excess of manufacturer's recommendations or specifications.

Tools needed for installation:

- 7/16" Wrench or Socket
- 1/2" Wrench or Socket
- 10mm Socket (long)
- #2 Phillips Screwdriver
- #3 Phillips Screwdriver
- Drill
- #2 Phillips Drill Bit
- Torx T-40 (provided)

Table of Contents

1. Inventory.....	3
2. Hardware Installation	
1. Bedrails.....	4
2. Angled Brackets.....	9
3. Cab Rails.....	10
4. Header Bar.....	11
5. Folding Frame.....	12
3. Soft Top Canopy Installation.....	13
4. Retracting the Soft Top.....	18
5. Optional Driving Configurations.....	20
6. Rear Screen Installation (*Purchased Separately)....	22
7. Softopper Care and Maintenance.....	23
8. Warranty Information.....	24

Your Softopper Includes the Following Pieces

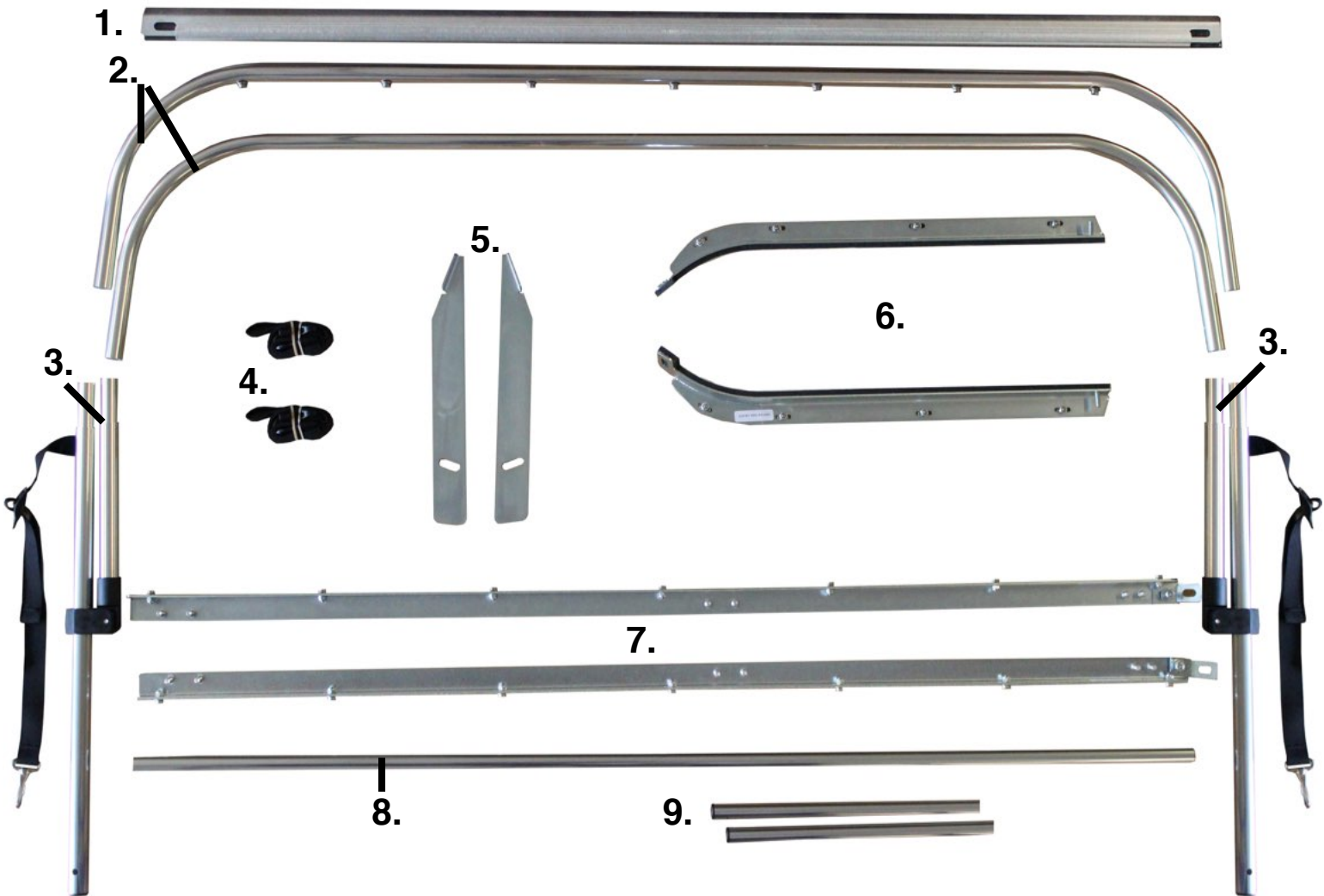

1. Header Bar
2. Front and Rear Cross Bars
3. Driver and Passenger Side Uprights
4. Cross Bar Straps
5. Driver and Passenger Side Angled Brackets
6. Driver and Passenger Side Cab Rails
7. Driver and Passenger Side Bedrails
8. Rear Bar
9. Rear Bar Inserts
10. 2 Bags Containing Various Parts and Hardware (not depicted above)
11. Softopper Canopy (not depicted above)

Bedrail Installation

****Note**** Driver side depicted in all photos and illustrations throughout instructions. Also, colored instructions are available on our website, softopper.com, under “Installation Instructions”.

1. Locate the Driver side bedrail, which has a sticker which indicates the Driver Side Front of the bedrail. Remove the white paper from the under side of the weather stripping. ****The weather stripping is NON-ADHESIVE and will not stick to your truck.**



2. Place the bedrail atop the side rail of the truck bed such that the inside edge of the bedrail is flush with the inside edge of the truck bed. Ensure that the snaps face the outside of the vehicle, and the “Driver Side Front” sticker is at the front of the truck bed.

Example of Assembled and Installed Driver Side Bedrail

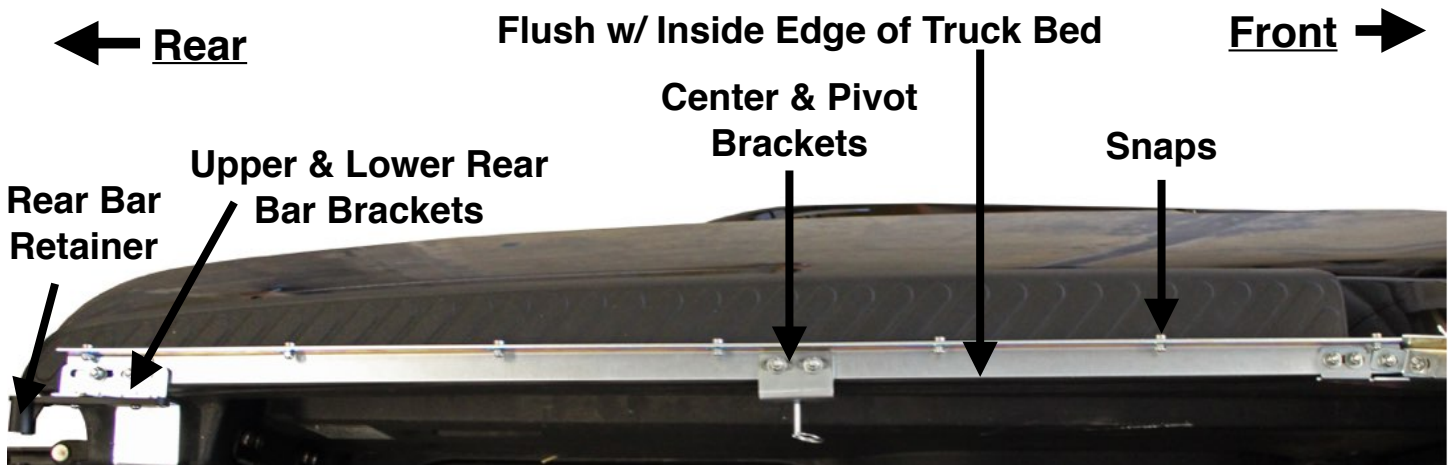

3. Also locate the 2 Rear Lower Brackets and the 2 Center Brackets in the long bag of hardware.

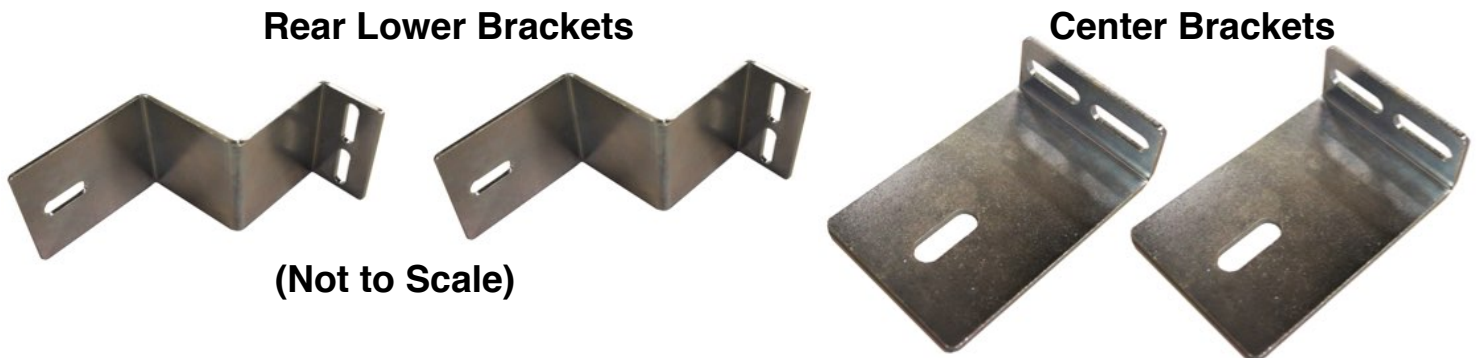

4. Place one of the Rear Lower Brackets (either will work) on top of the 2 standoffs at the **REAR** of the driver side bedrail through the 2 slots in the bracket. The bracket should come **IN** and **DOWN** into the truck bed compartment, as with all of the following brackets (photos on next page).

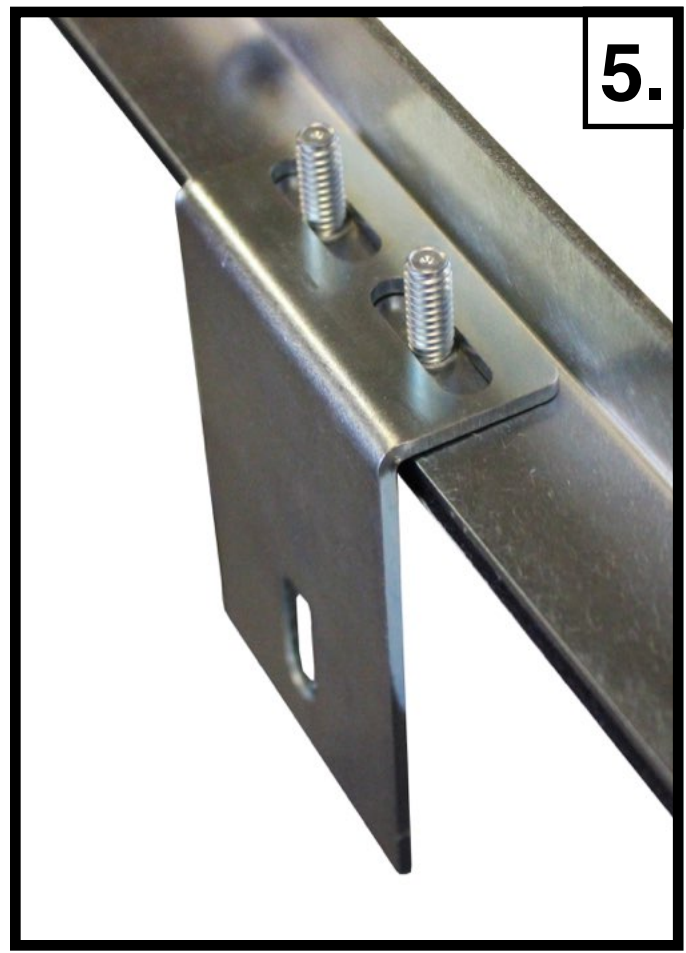
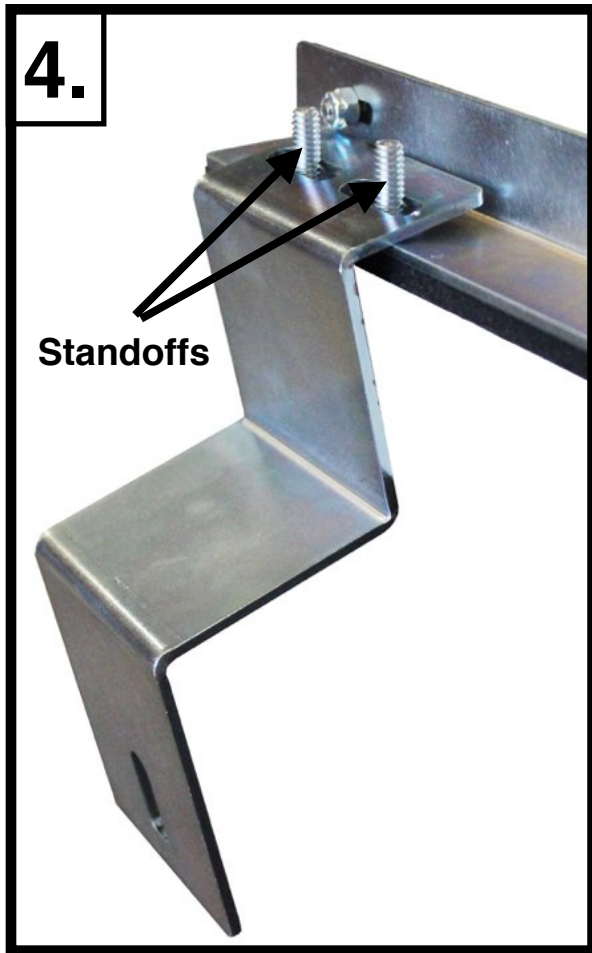

5. Place one of the Center Brackets (either will work) on top of the 2 standoffs at the **CENTER** of the driver side bedrail through the 2 slots in the bracket. The bracket should come **IN** and **DOWN** into the truck bed compartment (photo above).

6. Locate the 2 Pivot Brackets in the long bag.

7. Also locate the bag containing the 2 Upper Rear Brackets, 4 nuts, and 4 washers. (found in the 8x10 hardware bag).

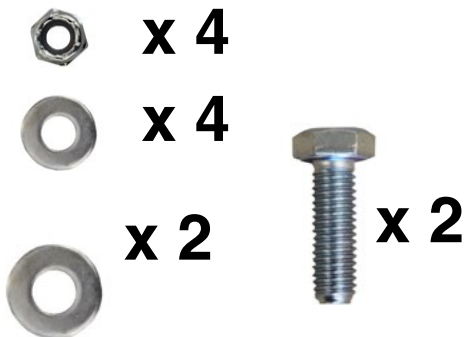
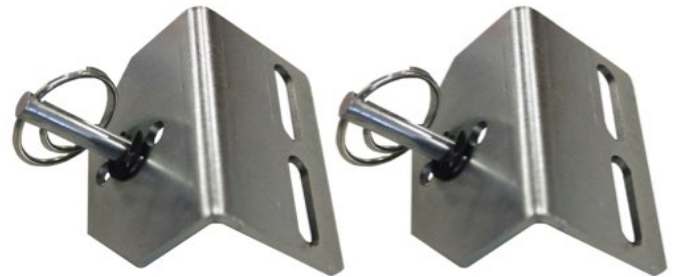

8. Place one of the Upper Rear Brackets (either will do) on top of the 2 standoffs at the rear of the bedrail on top of the lower rear bracket oriented as shown below. Place a small washer and a nut on each standoff, center the standoffs in the slots of the upper and lower brackets, and tighten securely using a 7/16" wrench or socket. Save the 2 remaining bolts and 2 larger washers for later in the installation process.

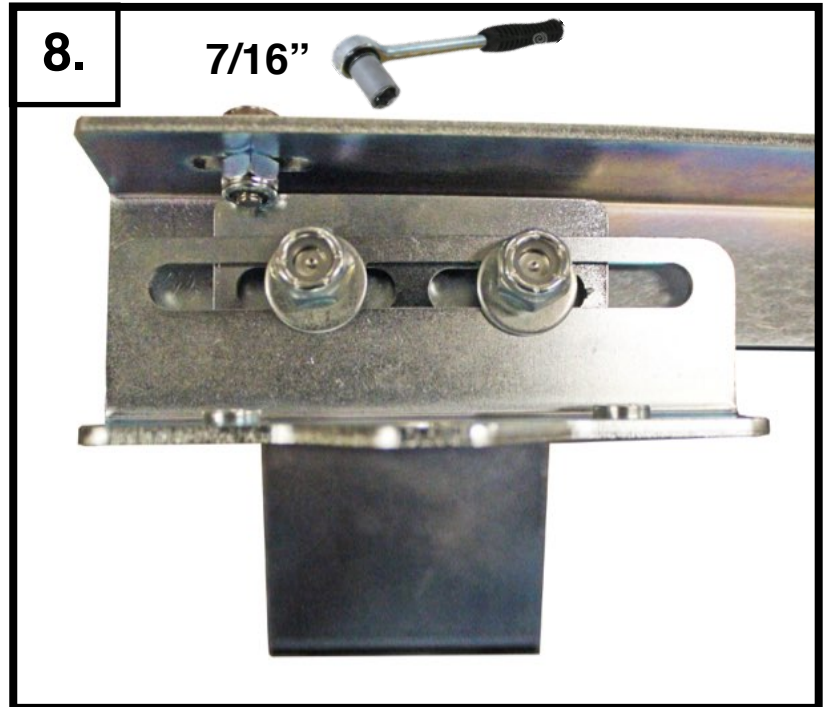

9. Place a Pivot Bracket on top of the Center Bracket and over the standoffs through the 2 slots in the pivot bracket. Ensure that the pivot bracket goes **IN** and **DOWN** into the truck bed compartment. Place a small washer and a nut on each standoff, center the standoffs in both bracket slots, and using a 7/16" wrench or socket tighten both nuts securely.

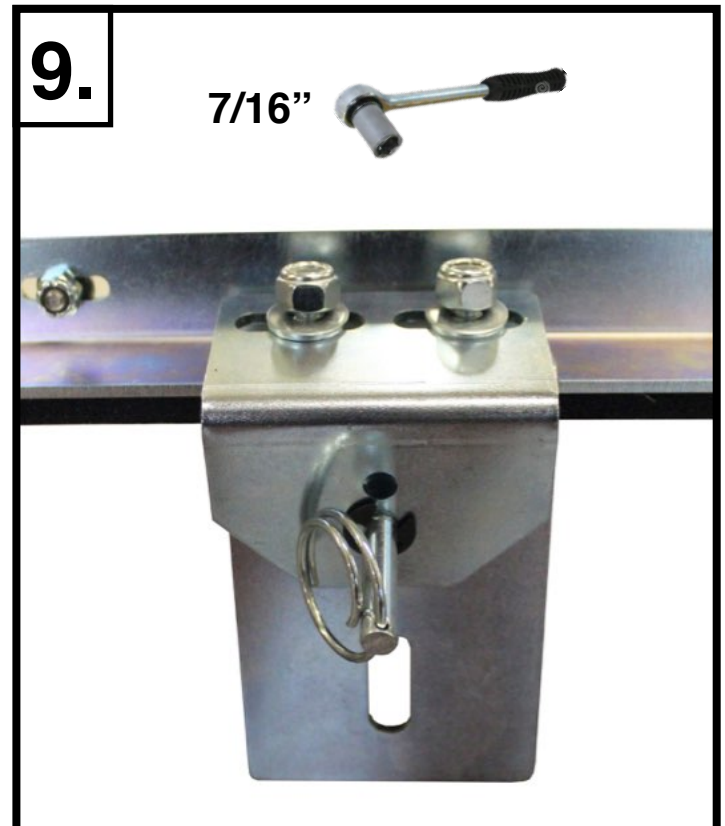

10. Locate the bag containing 2 black, plastic rear bar retainers, 4 small panhead screws, and 2 small, self-drilling screws. Locate the black plastic rear bar retainer that is labeled “B” on the plastic. Place the “B” piece on the driver side upper rear bracket and the “A” on the passenger side upper rear bracket. Ensure that the curved “C” slot goes IN and DOWN into the truck bed compartment as shown below. Using 2 panhead screws and a #2 Phillips screwdriver, secure the rear bar retainer to the Upper Rear Bracket, and center the screws in the slots. Save the remaining 2 small self-drilling screws for later in the installation process.

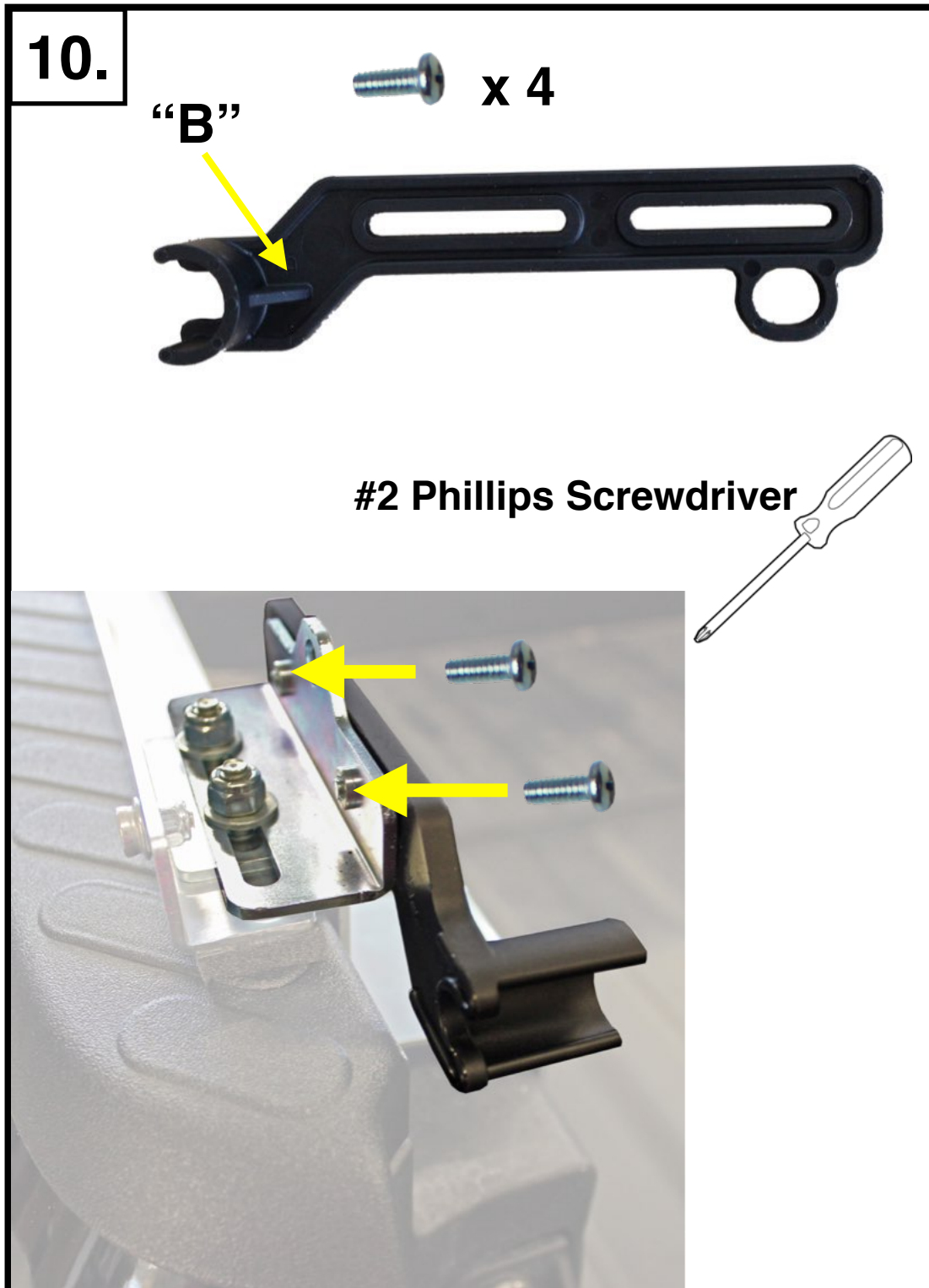

11. Repeat all of the above with the remaining passenger side bedrail assembly pieces.
12. Locate the Torx T-40 tool that we provided. Remove all 6 Torx bolts from inside the bed of the vehicle. There will be 3 on each side of the truck bed walls where the new bedrail brackets will need to be mounted (photos below).
13. Locate a small bag containing (4) 1" Panhead screws, 8 nuts, and 12 washers (2 nuts and 2 washers are extra in case you loose any). Using a #3 Phillips Screwdriver, securely fasten the bedrails to the truck by placing one washer and one panhead screw through the 2 lower brackets on each bedrail and the existing holes in the truck bed compartment in the locations depicted below. It may be necessary to remove any hardware that is already in the holes. Repeat on passenger side with remaining bedrail assembly.



#3 Phillips Screwdriver

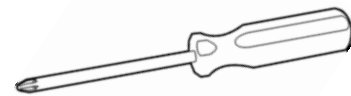

Angled Bracket Installation

1. Locate the 2 Angled Brackets, the 2 left over bolts from step #7 of the previous section, along with the 2 left over larger washers, and 4 nuts and washers from step #12 above.
2. Place the driver side angled bracket flange on top of the 2 standoffs at the front of the bedrail through the slot on the angled bracket flange as shown. Place a small washer and a nut on each standoff and loosely finger tighten. Place the bolt and a larger washer through the other slot in the angled bracket and into the existing hole near the front of the truck bed compartment. After aligning properly, tighten bolt using a 1/2" socket. Tighten the 2 nuts using a 7/16" socket. Repeat on passenger side.

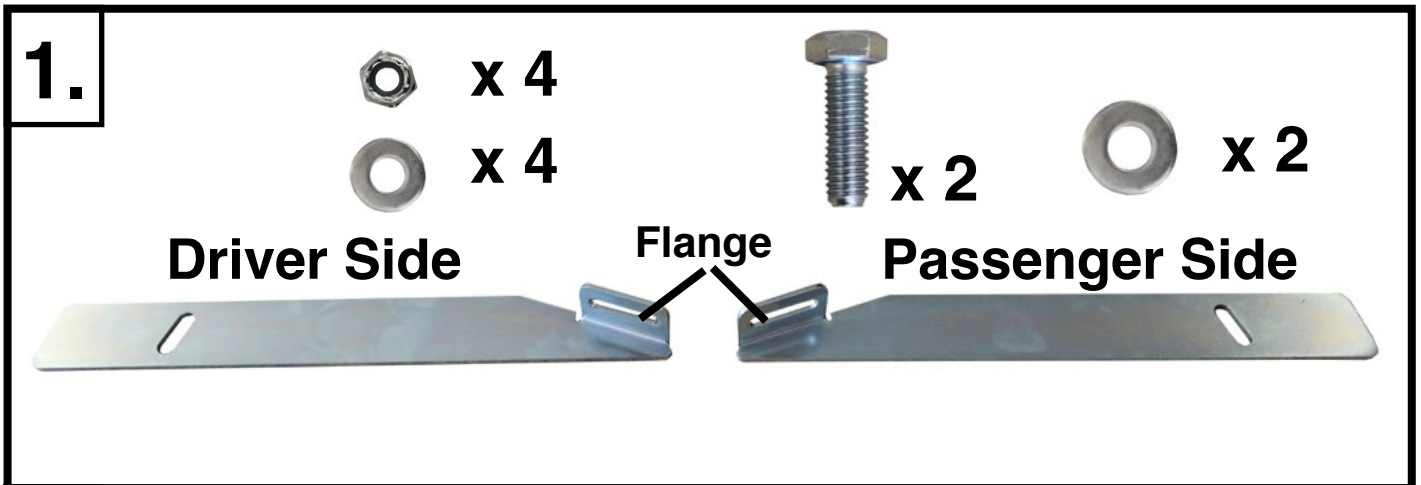

Cab Rail Installation

1. Locate the Driver and Passenger Side Cab Rails. There is a sticker which designates the driver side cab rail. Also locate 2 regular nuts and washers from the previous bag.

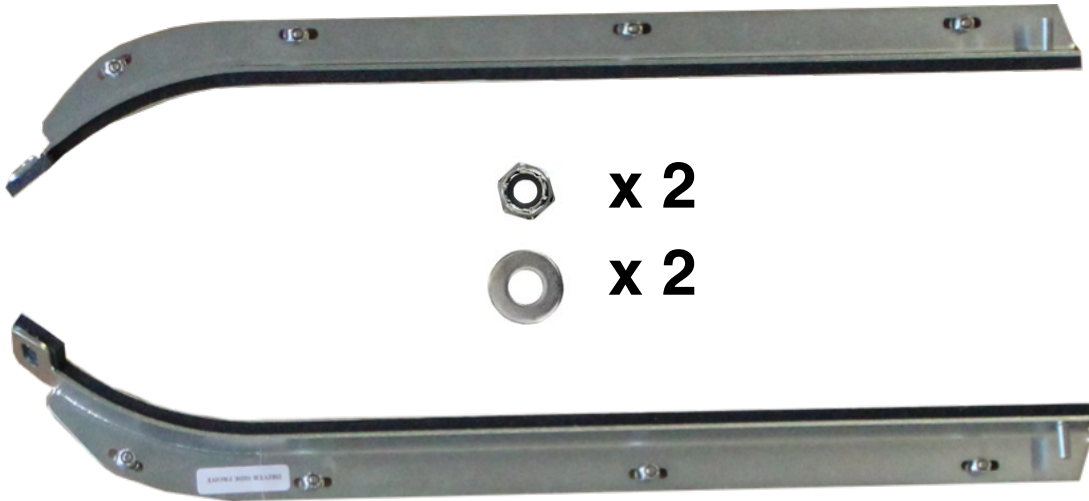

2. Remove the white paper from the bottom of the weather stripping. Place the driver side cab rail atop the vertical/diagonal side of the truck bed from the bedrail to the roof with the snaps facing out just like on the bedrails. Ensure that the inside edge is flush with the inside edge of the truck rail.
3. Locate the small bracket that is already installed on the front of the bedrail, and place the front bracket hole over the standoff at the bottom of the cab rail. Place a washer and a nut on to the standoff and finger tighten. Repeat on passenger side. The cab rail installation will continue later in the installation process.



Header Bar Installation

1. Locate the Header Bar, and the small bag containing 2 panhead screws, 2 washers, and 2 coupler nuts.
2. Locate the hole on the roof of the vehicle which will line up with the slot in the top of the cab rail.
Remove the plug and the bolt which may be installed in the hole.
3. Place a coupler nut down into the hole and tighten it securely to the standoff which is in the hole using a 10mm, long socket.
Repeat on passenger side.
4. Place the top holes of the cab rails in line with the roof hole.
5. Remove the white paper from the bottom of the weather stripping on the header bar.
6. Place the header bar atop the roof of the vehicle, on top of the cab rails, with the opening of the upper curved piece facing the front of the vehicle. Align the 2 holes on each side with the holes in the cab rails and the roof.
7. Place a washer on top and a screw through each hole and all of the weather stripping, and tighten each screw securely using a #3 Phillips screwdriver, ensuring that the cab rail is still in proper alignment.
8. Securely tighten the 2 nuts at the bottom of each cab rail.
9. Locate the (2) 2" pieces of bulb seal. Remove the red, plastic protective film. Place on the header bar just behind the screws with the little flange on the bulb seal facing the rear of the vehicle as shown. It may be necessary to trim the bulb seal to fit perfectly between the curved piece of the header bar and the edge of the cab rail.

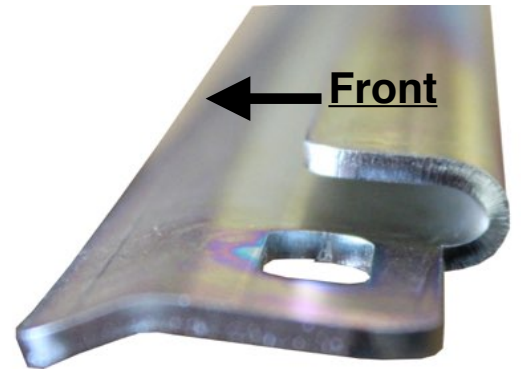

Folding Frame Assembly and Installation

1. Locate the 2 Cross Bars and the 2 Folding Frames Uprights (4 depicted below).

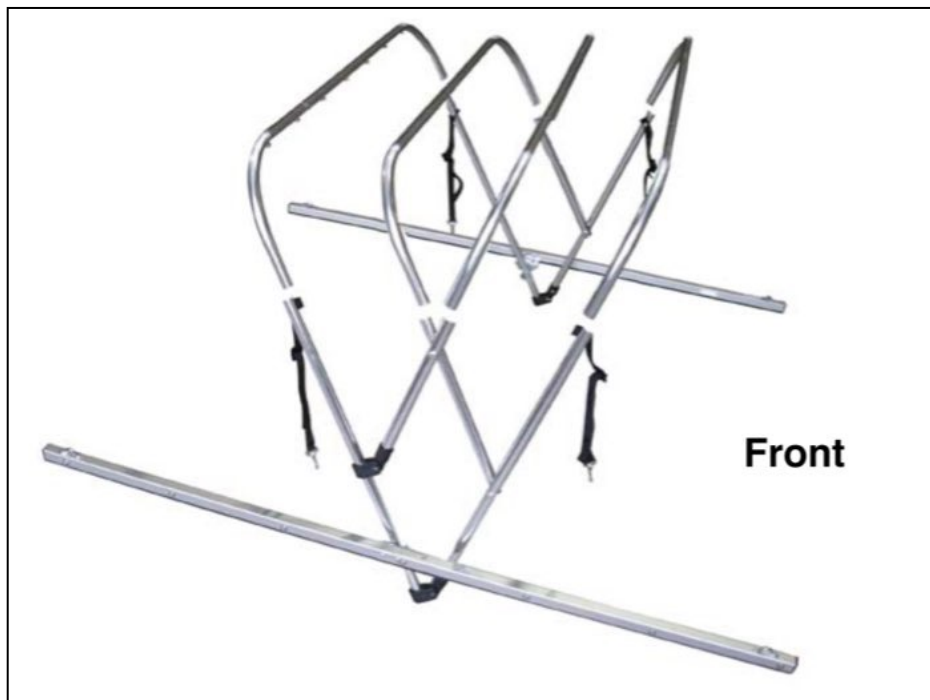

2. Join the 2 cross bars to the 2 folding frames (4 depicted below) by coordinating the **COLORED DOTS** provided on the pieces and ensuring the push pins are locked into their holes.

****Important: Keep fingers clear of the sharp, metal junction where the cross bars will meet the folding frame when clipping them together. Injury is likely if fingers get pinched.**



3. ****Tip: It helps to stand the folding frame uprights up, and with another person, or a table to rest one end of the cross bars on, jiggle the cross bars down to join them to the uprights. (4 cross bars depicted above)**

4. Remove the safety rings from the pivot pins in the pivot brackets by turning the ring.

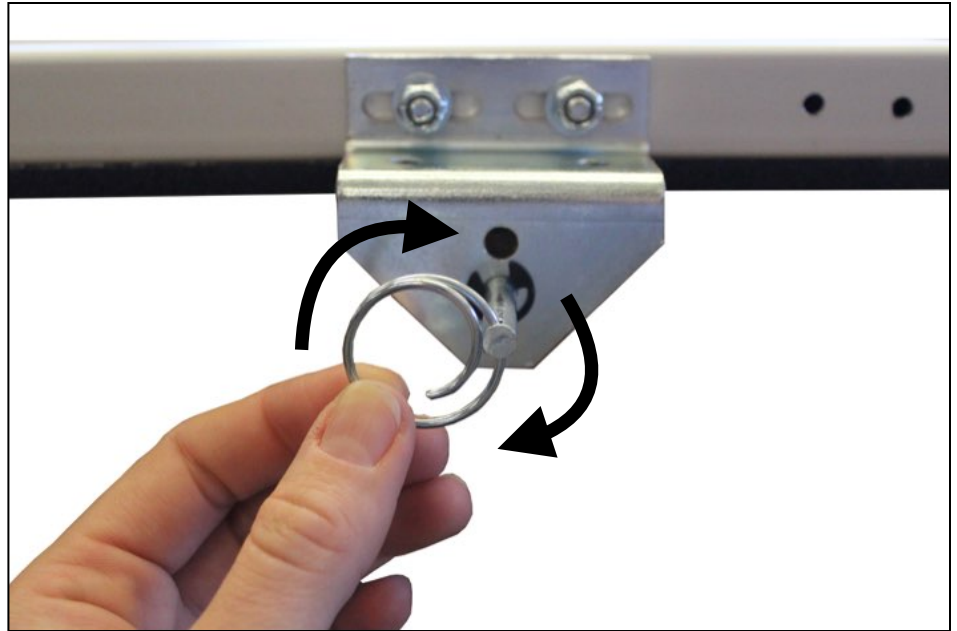

5. Using the pre-drilled holes near the bottom of the folding frame, slide the frame onto the pivot pins on each bedrail ensuring the **forward cross bar is forward**. The forward crossbar is the one with the **RED DOT**. Secure the safety rings back on. [The most common installation error is installing the frame on backwards. View photo to ensure correct orientation of the folding frame.]

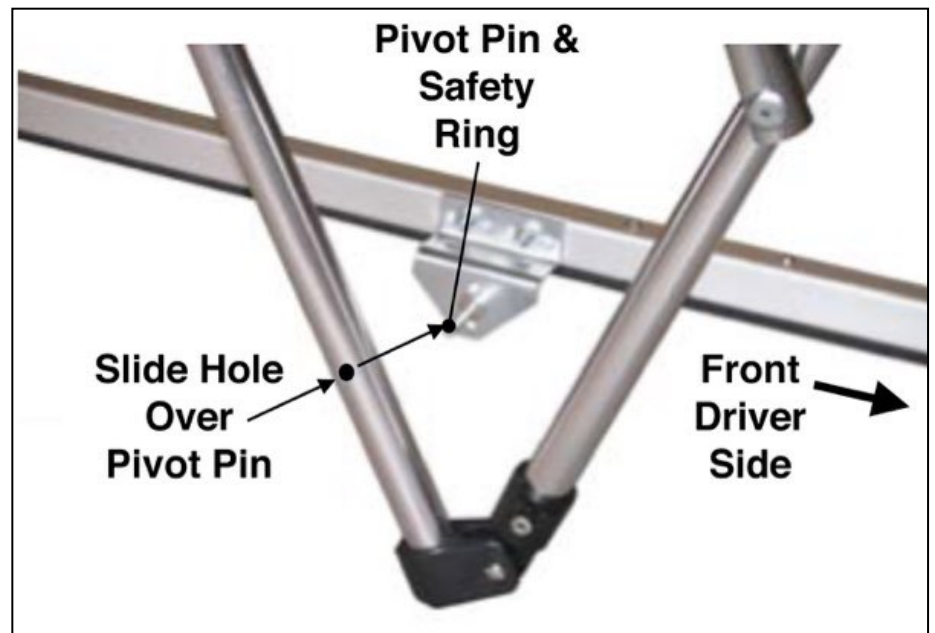

6. **Note:** when reopening the frame from its front position, you must raise all of the cross bars to approximately cab-height before opening the folding frame completely. If the rear cross bar is raised on its own, it will force the forward most cross bar into the cab window.
7. Leave the 4 safety straps that are hanging on the folding frame unclipped for now.

Soft Top Canopy Installation

1. With the tailgate open, lower the folding frame to the rear of the vehicle.
2. Place the canopy on the tailgate with the rear canopy snaps facing up as shown.
3. Locate the 2 crossbar straps from the kit. Place the 2 crossbar straps between the 2nd and 3rd snaps on each end of the rear cross bar as shown.



4. Attach the two upper tensioning straps to the forward cross bar by releasing the side release buckles and reattaching. Make sure there are no twists in the straps. Also ensure that when the frame is put into its upright position, the buckles of the straps will face down into the truck bed for easy use. Keep loose for now.
5. Snap the canopy to the rear cross bar by slipping the fabric **UNDER** the bar and around as shown.
6. Stand on the tailgate and carefully lift the entire canopy and folding frame up and forward until you can rest the front of the canopy over the cab roof and slide the plastic that is sewn into the front of the roof into the curved opening in the header bar. Pull back on the entire canopy making sure the plastic stays in the header bar as you let the canopy rest in its open position.





7. Loosely latch the 2 rear safety straps that are already installed in the folding frame to the holes on the tops of the rear upper brackets.
8. Undrape the side panels and rear window panel, and let them hang loosely.
9. On the driver side, snap all of the corresponding snaps to the cab rail.
10. On the same side, while pulling down on the rear cross bar, tighten the rear safety strap. The safety straps should be snug, not loose nor overtightened.
11. Connect the rear most snap on the side panel to the rear most snap on the bedrail.
12. Tighten the safety straps further to relieve excess tension on the snaps. Note that it is a good idea to share tension between the safety straps and the snaps instead of having all the tension only on the snaps. This will also help with any wrinkles in the corners.
13. Now snap the rest of the snaps on the driver side.
14. Repeat the above on passenger side. ****Note that we recommend snapping the front most and rear most snaps first each time you close the top.** This makes it easier to snap the remaining snaps and align the canopy properly.

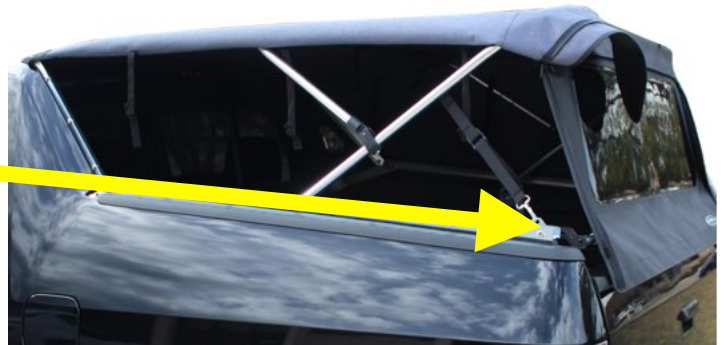

15. At this point or any other point during the life of your Softopper, if the canopy is too loose or too tight, you can move the pivot pin to a higher or lower hole in the pivot bracket. Be sure to reinstall the black, plastic E-Clips onto the pivot pins. Also, ensure with any new adjustments that the folding frame does not impact the cab window.
16. Make sure the E-Clip is in the small indent in the pivot pin. It helps to use the flat edge of something metal to push the E-Clip on.

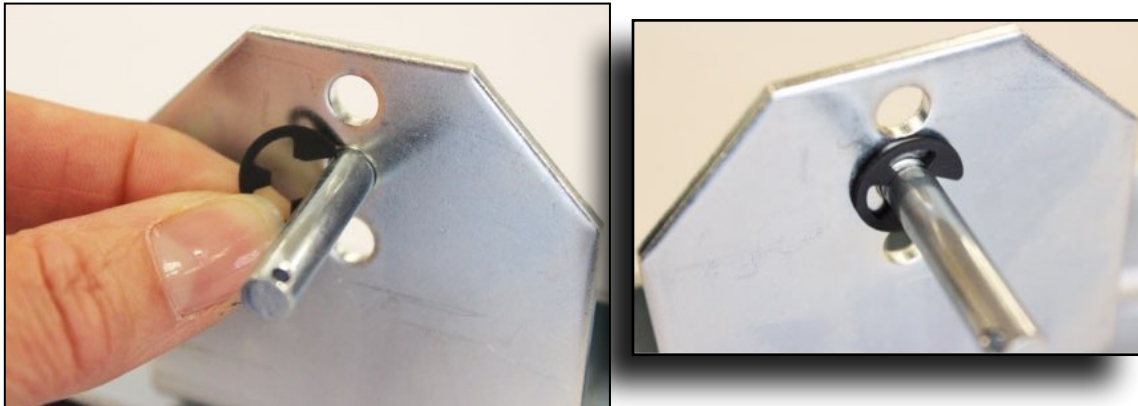

17. Locate the straight Rear Window bar, the (2) 12" bars, and the two remaining self drilling screws that were in the bag.



18. Insert the 2 shorter bars into the ends of the longer bar with the plastic end caps facing out.
19. Standing at the rear of the vehicle, push the two ends of the bar assembly into the rear plastic bar retainers while adjusting the length of the bar assembly as necessary. It should fit securely end to end into the given space within the plastic bar retainers as shown.
20. Center the long bar over the other two 12" bars.
21. Using a drill and a #2 Phillips bit, screw the 2 small self drilling screws into the pre-drilled holes to join the 3-bar assembly.



22. Now remove the bar and slide it into the sewn-in sleeve at the lower part of the rear window panel. Center the bar and snap it into the bar retainers.
23. Zip closed the rear window panel.
24. Close the tailgate while lifting up slightly on the fabric hanging at the bottom of the window panel.
25. **Optional: Use the provided extra strips of velcro to hold the bottom of the rear window flap to the tailgate. Wipe clean and dry the tailgate surface before placing the sticky side of the velcro onto the vehicle. Before putting excessive tension on the velcro, we recommend letting it adhere for 24 hours.

Installation Complete

Retracting the Soft Top

1. Undo all side snaps.
2. Raise the rear window panel zippers all the way to the top without disconnecting them.
3. Release the rear window retainer bar.
4. Fold the side panels up onto the roof canopy neatly.
5. Fold the rear window panel up onto the roof as well with the upper zippers still connected.
6. Release the 2 rear safety straps.
7. Standing on the tailgate, or from the side of the vehicle, fold the folding frame forward with the entire canopy on top of the cross bars. The top should fold itself nicely into sections without damaging the windows. Ensure the correct folds are made the first few times.



8. ****Clip the 2 rear safety straps onto the bedrail loops and tighten them for safety while driving.**



9. Optional: Place your Softopper boot cover (purchased separately) around the Softopper to make for clean, easy storage on or off the vehicle.
10. To fully remove the Softopper, release all 4 safety straps, remove the 2 safety rings from the pivot pins, and completely remove the folding frame. Reinstall the safety rings. Optional

boot cover can be placed around the Softopper to make for clean, easy storage on or off the vehicle.

11. **Optional: Roll the side panels and the rear window up to create an open air truck bed without removing the upper canopy as shown. Carefully and neatly roll up the panels and secure them by buckling the straps on the canopy. The truck can be driven with the rear window rolled up, and the sides rolled up. However **DO NOT** drive the vehicle with the side panels rolled up and the rear window down due to wind resistance potentially causing damage to the rear window or release of the rear bar from the bar retainers.



12. **Optional: Roll the side panels and the rear window up to create an open air truck bed without removing the upper canopy as shown. Carefully and neatly roll up the panels and secure them by buckling the straps on the canopy.

Optional Driving Configurations

1. Retracted without boot cover.
**Secure both Safety Straps to bedrail loops!



2. Retracted with boot cover (purchased separately; makes for clean, easy storage on or off the vehicle). **Leave one safety strap on each side out of the boot cover and secure them to bedrail loops!



3. Rear window rolled up and buckled.
4. Rear window removed.
5. Front panel removed.



6. Side panels and rear window rolled up and buckled. **Rear window MUST be rolled up if side panels are rolled up.



7. Side panels partially rolled up.



8. Softopper canopy and folding frame removed from vehicle. Leave bedrails installed. To fully remove the Softopper, release all 4 safety straps, remove the 2 safety rings from the pivot pins, and completely remove the folding frame. **Reinstall the safety rings.** Optional boot cover can be placed around the Softopper to make for clean, easy storage on or off the vehicle.



Rear Screen Installation

***Purchased Separately**

1. Open the tailgate. Unzip the rear window.
2. Completely remove the rear bar from the rear window.
3. Sit inside the Softopper on the tailgate, facing the rear window.
4. Undo the small, velcro flap covering the top of the zippers on each side of the rear window, and unfasten the zippers from the other half on the Softopper roof.
5. Pull the window to completely detach it from all of the velcro holding it on at the top. Gently place the window in a storage location where it will not get scratched.
6. While still sitting in the truck bed, place the screen panel right side out.
7. Attach the zippers first, and only pull them down a little bit. Secure the small velcro flap over the top of the zipper.
8. Make sure the roll-up straps are on the inside of the screen panel.
9. Find the small hole in the screen panel that is at the top, in the center. Line the hole up with the center snap on the cross bar above the velcro.
10. Secure the velcro all the way across the top of the screen panel evenly. No velcro should be showing on the outside of the window panel.
11. Slide the rear bar into the pocket at the bottom of the screen panel.

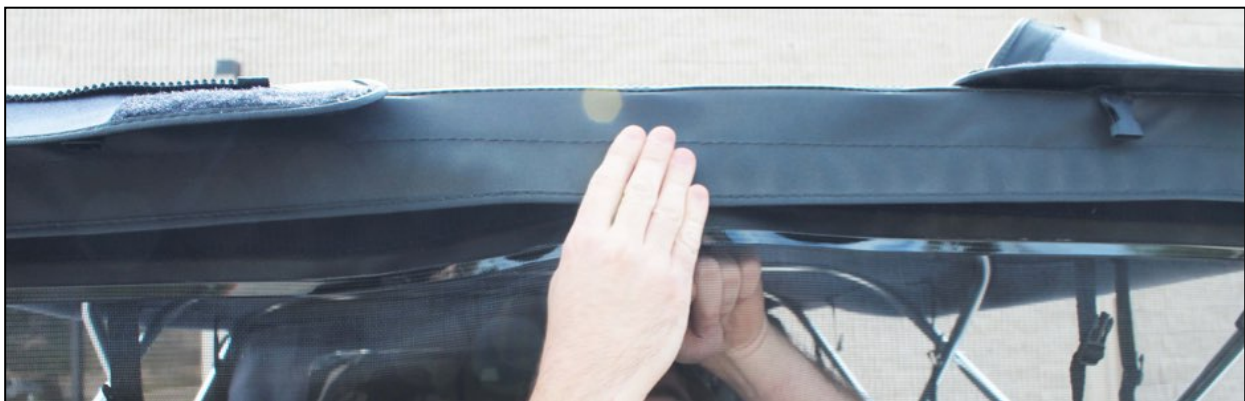

Softopper Care and Maintenance

Your top is made of the finest materials available. To keep it looking new and for product longevity and durability, it will need periodic cleaning and maintenance. All pieces are individually replaceable; call 1-800-810-7227, or order your parts online at Softopper.com.

Washing: The fabric should be washed from time to time using a mild soap and warm water. Be sure to rinse all soap off the top when washing is complete.

Vinyl Windows: Windows should be kept clean to avoid scratching. Wash with a water-soaked sponge or cloth and a mild dishwashing detergent. **Do not use a coarse brush on the windows and never wipe the windows when they are dry.**

COLD WEATHER: As with all automotive and marine vinyls, extreme care must be taken when rolling up or folding the windows in cold temperatures. **Vinyl becomes stiff in cold temperatures and may crack. Retracting the Softopper in cold temperatures is not recommended and will void the warranty for the windows (see Warranty information for more detail on length of window warranties).** When opening the rear of the Softopper in cold weather, be sure to raise the zippers as high as possible so that any folding will occur to the topper fabric and not to the vinyl window.

Zippers: Keeping the zippers clean and lubricated with a silicone lubricant will help prevent damage and keep the zippers in smooth working condition.

Leakage: As with any sewn automotive top there is always a slight risk of leakage. **Right out of the box the Softopper may not be 100% waterproof.** If you experience any water seeping through at the seams, apply **Seam Sure** (supplied), on the **INSIDE** of the affected seams. It will look very messy on the outside of the canopy. **Shake** Seam Sure well and apply liberally to the inside seams concentrating on areas where needle and thread penetrated the fabric.

Snaps: Keep snaps clean and lubricated with a silicone lubricant to help prevent snaps from sticking to the studs. If a snap does become stuck to a stud, use a screwdriver and gently pry apart to prevent damage to the snap or top fabric. If any snaps need to be replaced due to sticking or damage please call Softopper and we can send out a small do-it-yourself repair kit.

For further information please contact:
Softopper LLC, customer service
(800) 810-7227 or (303) 304-0533

Warranty

We warrant all of our Softoppers to be free from defects in material and workmanship for a period of one year, with the exception of vinyl windows and zippers, provided there has been normal use and proper maintenance.

Vinyl Windows are warranted for a period of 3 months from the date of purchase.

Zippers are guaranteed to be in perfect working condition when leaving the factory. Due to atmospheric conditions, dirt, sand, road grime, dust, and abrasive cleaners, etc., zippers are warranted for a period of 6 months from the date of purchase.

Toyota 4 Runner, Jeep Wrangler, Blazer, Jimmy, Scout, Bronco, and RamCharger side curtain windows are warranted for 45 days from the date of purchase. Retracting or closing the top when the temperature is below 40 degrees may void the warranty on the side windows, as clear vinyl plastic can crack very easily at these temperatures. Use caution when retracting the top or cleaning off the windows in freezing temperatures.

Returns must be made within 30 days of purchase, and must be pre-approved and have Softopper's issued RGA number attached. Any defective items must be returned with proof of purchase to Softopper 4750 Nautilus Court South, Unit B Boulder CO 80301, **freight pre-paid**. Items returned must be carefully packed, in clean condition, with plastic windows protected from scratching and creasing. This warranty does not cover damage resulting from abuse, misuse, alteration, accident or damage in transit. Softopper's obligations under this warranty are limited to the aforementioned **repair** or **replacement** of warranty defects for which return authorization has been received during the warranty period, and Softopper SHALL NOT BE LIABLE FOR ANY INCIDENTAL OR CONSEQUENTIAL DAMAGES ARISING FROM BREACH OF THIS OR ANY IMPLIED WARRANTY. This warranty applies to the original purchaser only. All remedies under this warranty are limited to repair or replacement of any item or items found to be defective by the factory within the time period specified.

For further information or request for repair work, please contact:

Softopper LLC, customer service
(800) 810-7227 or (303) 304-0533